

# FRIGIDAIRE

## GALLERY

1.9 Cu. Ft. Over-The-Range Microwave

Over-The-Range Microwave

Available Products: GMOS1962AF

Available Colors: Stainless Steel

Version: 08/22



### Product Specifications

#### Cooking Controls

Clock	Yes
Defrost Time	Yes
Defrost Weight	Yes
Number of Power Levels	10
Cooking Power	1000 Watts

#### Ventilation System

Ductless Vent	Yes
Exhaust Fan Speeds	3
Minimum Air Flow Capacity	105 CFM
Maximum Air Flow Capacity	400 CFM
Charcoal Filter Included	Yes
Removable Grease Filter	Yes
Grease Filter Included	Yes
Grease Filter Dishwasher Safe	Yes
Grease Filter Quantity	2
Ducted Vent	Yes

#### Additional Settings

Child Lock	Yes
Clock Display On / Off	Yes
Clock Settings	Yes
Demo On / Off	Yes
Setting Turntable On / Off	Yes
Setting Weight Lb / Kg	Yes
Surface Cooking Light	Yes
Timer On / Off	Yes
Vent Fan	Yes

#### Exterior

Door Swing	Side-Swing Door
------------	-----------------

#### Surface Light System

Lighting Type	LED Strip
Number of Lights	1
Number of Light Settings	2

#### Electrical Specifications

Amps @ 120 Volts	13.5 Amps
Connected Load @ 120V	1.55 kW
Voltage Rating	120 V

#### Microwave Cooking

Auto Cook	Yes
Sensor Cooking	Yes
Popcorn	Yes
Potato	Yes
Melt / Soften	Yes
Veggies	Yes
Reheat	Yes

#### Microwave Control Features

+ 10 Seconds	Yes
+ 30 Seconds	Yes
Quick Start	Yes

#### Display

Display Interface Color	White
Display Type	Capacitive Touch
Control Location	Right

#### Internal Specifications

Interior Color	White
Interior Light Quantity	1
Interior Light Type	LED Strip
Interior Light Wattage	1.2 Watts
Turntable Diameter	13 5/8"
Turntable Material	Glass

#### Dimensions and Volume

Height	16 3/8"
Width	29 7/8"
Depth	15 3/4"
Depth With Door 90° Open	44 3/8"
Microwave Interior Height	9 1/8"
Microwave Interior Width	19 13/16"
Microwave Interior Depth	13 3/4"
Microwave Capacity	1.9 Cu. Ft.

#### General Specifications

Prop 65 Label	Yes
Warranty - Labor	1 Year
Warranty - Parts	1 Year

For planning purposes only. We reserve the right to change specifications or discontinue models without notice. Refer to Product Installation Guide for detailed installation instructions on the web at [frigidaire.com / frigidaire.ca](http://frigidaire.com/frigidaire.ca) Electrolux Major Appliances, N.A.

USA • 10200 David Taylor Drive • Charlotte, NC 28262 • Charlotte, NC 28262 • 1-877-4electrolux (1-877-435-3287) • [frigidaire.com](http://frigidaire.com)  
CANADA • 5855 Terry Fox Way • Mississauga, ON L5V 3E4 • 1-800-265-8352 • [frigidaire.ca](http://frigidaire.ca)

## Safety Certifications and Approvals

UL Listed	Yes
cUL Listed	Yes

## Installation Diagram

Locate 120V/60Hz grounded outlet inside upper cabinet

Microwave MUST be mounted to BOTH a top cabinet† AND a wall.\*

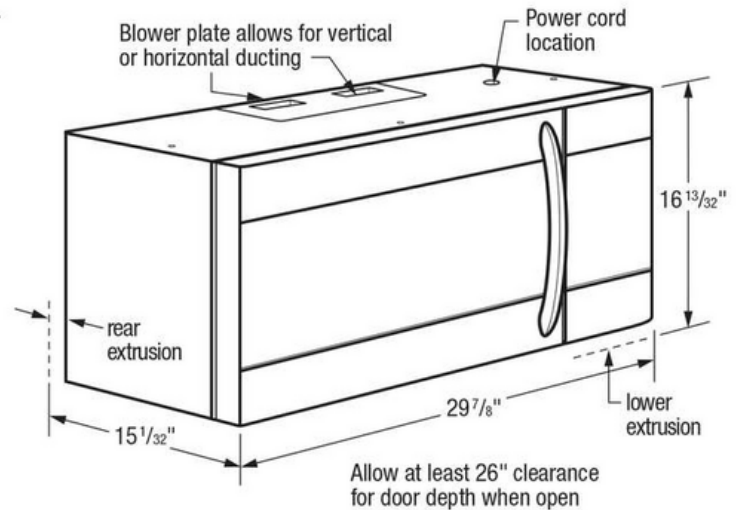
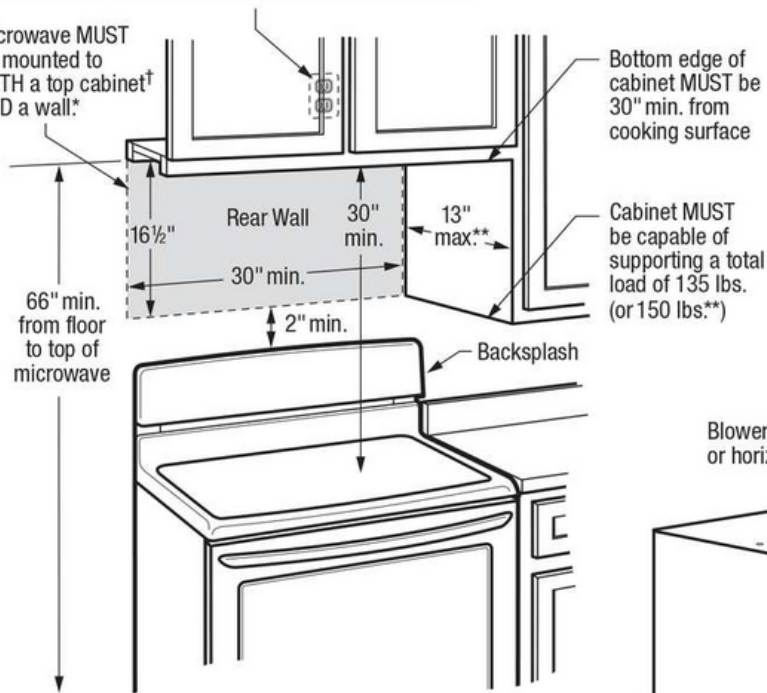

†When installing beneath smooth, flat cabinets, refer to cabinet template for detailed power cord clearance instructions

\*Can NOT be installed in island or peninsula cabinet arrangements

\*\*If cabinet depth (including doors) is deeper than 13", unit MUST be spaced out from rear wall using adequate materials (supporting 150 lbs.) to allow proper top vent air exhaust/intake