

Flexible MOULDINGS



4264 Old Linwood Road
Linwood, NC 27299
1-800-861-0734
FAX 1-800-861-0737
www.carterflex.com



SELECTION GUIDE

CarterFlex

For builders and designers who appreciate the architectural prominence and beauty of moulding, Carter Millwork, Inc. has become the solution for both small and large installations. Whether the need is one uniquely designed style or hundreds of feet with optimum consistency, we satisfy the demand with quality assured mouldings. Each piece is individually inspected to provide the highest quality control. Here are features that make CarterFlex one of the most desired moulding products in the building industry.

- **MATERIALS**
Polyurethane Composite Material
- **WARRANTY**
Lifetime warranty for products
- **MOULDING SIZES**
Same sizes as wood
- **FLEXIBILITY**
6 standard sizes cover 1/8 to 7/0 Half Round
- **FINISHING**
Accepts paint or stain
- **MACHINING**
Use same tools as wood
- **STRENGTH**
Heat - Minimal Effect
Cold - Minimal Effect
- **VALUE**
Low cost with excellent performance

We are available to provide any ordering information or answer any questions Monday through Friday. You may order by calling 1-800-861-0734 or sending faxes to 1-800-861-0737.

We ship all orders Prepaid and delivery of Stock Items is made within one or two days for UPS shipments. We schedule regular deliveries with common carriers for larger orders.



Carter Millwork has maintained a leadership role by helping artisans create their vision through moulding replications.

Our Made-To-Match process (MTM), gives Carter Millwork the unique opportunity to match any style our customers wish to replicate. Through this process, our skills and technology allow us to reproduce the most intricate and minimal moulding designs provided for replication.

By working with our skilled order specialists, we can fashion radius pieces to match your original samples. Typically, we create 12 ft. molds of the samples that you send. We replicate the moulding to fit your templates and specifications. We can ship both straight and curved mouldings to fit your project needs.

Because we give each order special attention, we have a reputation of exceeding industry delivery standards. We stock many profiles so that we can provide accelerated delivery. Many of these items are marked with an "S" in this guide; however, we have many more designs that may fit your ideas. We can search our inventory of mouldings using a small moulding piece or your tracing as reference. No order is too large or too small. Call us.



1-800-861-0734

Ordering Information

We are always happy to help you with any specification questions before you enter your order.

These are some commonly requested configurations and typical information we need for production.

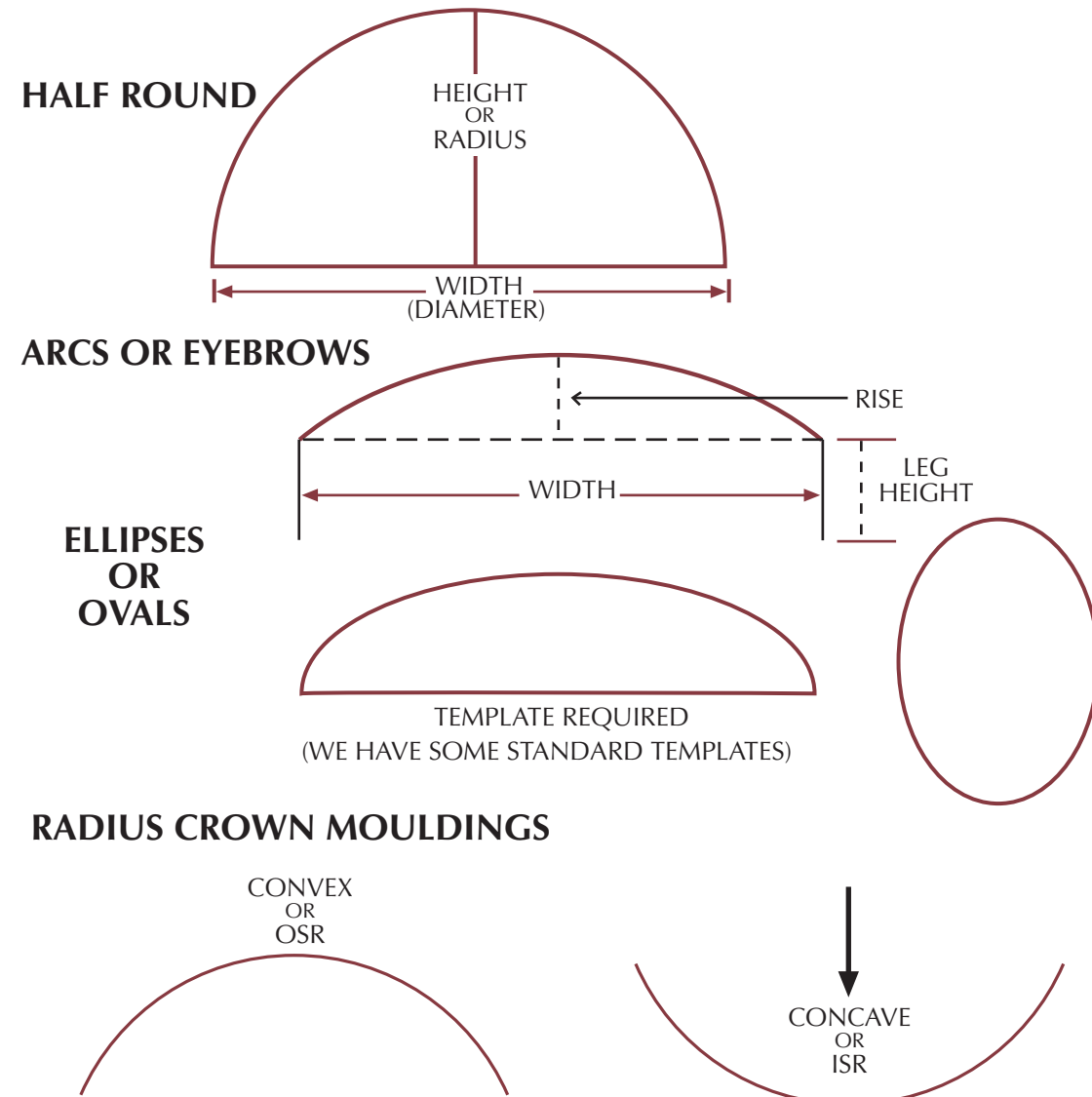

Please provide a radius dimension of wall or width of unit and how much the wall or ceiling recesses (ISR) or projects (OSR).

NOTE: Curved ceilings or dormers (Barrel Vaults) are convex or OSR applications. Please specify at time of order.

IMPORTANT: Straight (lineal, non pre-radiused) pieces will only be suitable for certain applications. Please call us with any information to insure appropriate material is ordered and provided.



The drawings shown in this book are a reference and may be different than actual mouldings produced.

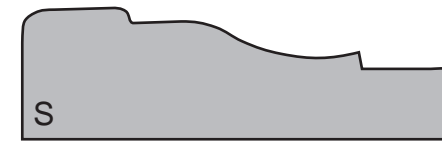

CM356
1¹/₁₆ X 2¹/₄ in.

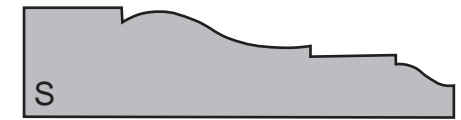

CM366
1¹/₁₆ X 2¹/₄ in.

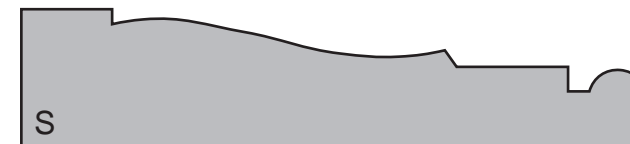

CM445
1¹/₁₆ X 3¹/₄ in.



CM444
1¹/₁₆ X 3¹/₄ in.

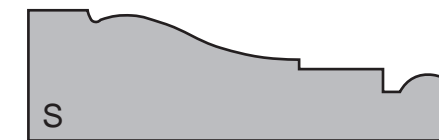

CM376
1¹/₁₆ X 2¹/₄ in.

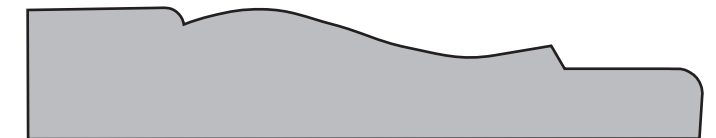

CM444A
1¹/₁₆ X 3¹/₂ in.



CM470
1¹/₁₆ X 3¹¹/₁₆ in.



CM442
1¹/₁₆ X 2¹/₄ in.

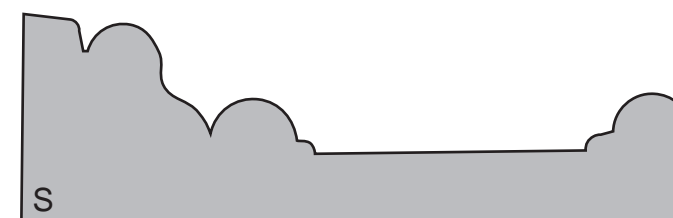

CM1
1¹/₁₆ X 3¹/₂ in.

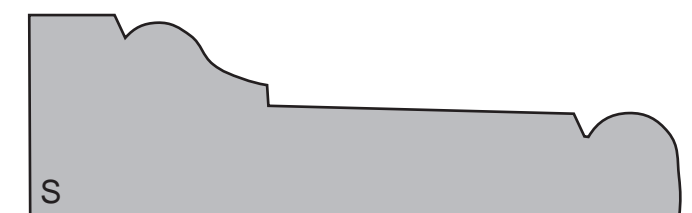

CM97
1¹/₁₆ X 3¹/₂ in.

CarterFlex

INSTALLATION

USE:

This flexible moulding is designed for interior and exterior use. This product is stable and will not absorb moisture. However, the use of a paint or gel stain and sealer is recommended for all applications.

MACHINING

Conventional woodworking tools can be used with this material. Material can be cut, sanded and shaped with ease. Miter saws work well when trimming this material. As with all types of trim material, use care when marking and cutting.

FASTENING

Always install moulding material in a relaxed position. Use construction or panel adhesive or mastic type glue continuously on back side and nails to secure moulding material in place until adhesive bonds.

- DO NOT use staples to fasten material.
- Keep nails to a minimum, no closer than 6" between nails.
- Do not nail closer than 3/8" from edge of moulding.

CLEANING

Prior to finishing, clean the moulding by wiping with a cloth using soap and water, paint thinner or any mild solvent to clean any dirt or grease that may have accumulated during installation.

PAINT & STAINING

All CARTERFLEX material is paint grade and most profiles have grain and can be stained. Inspect for grain or call for information on compatibility of staining. Staining of CARTERFLEX material requires the use of a gel type stain.

LIFETIME WARRANTY

Carter Millwork, Inc. warrants that for the "lifetime" ownership, the CARTERFLEX moulding is free from defects in material and workmanship. "Lifetime" means as long as the original purchaser owns the structure to which the CARTERFLEX moulding has been properly attached. Carter Millwork, Inc. will repair or replace at its option any CARTERFLEX moulding that has failed as a result of defective material and workmanship. This remedy is the purchaser's exclusive remedy for breach of warranty hereunder.

THE FOREGOING WARRANTY IS IN LIEU OF ALL OTHER WARRANTIES, EXPRESS OR IMPLIED, INCLUDING BUT NOT LIMITED TO THE IMPLIED WARRANTIES OF MERCHANTABILITY AND FITNESS FOR A PARTICULAR PURPOSE.

At no time will Carter Millwork, Inc. be liable for more than the original purchase price of the moulding, nor will Carter Millwork, Inc. be liable for any special, incidental or consequential damages based upon breach of warranty, breach of contract, loss of profits, loss of savings or revenue, loss of use, the claims of third parties and injury to property. Some states do not allow limits on warranties or on remedies for breach in certain transactions. In such states, the limits in this paragraph and the preceding paragraph may not apply.

It shall remain the responsibility of the customer to insure that the moulding purchased is designed for their particular installation.

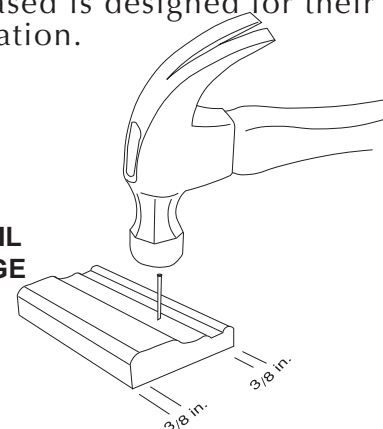

TO AVOID DAMAGE DO NOT NAIL CLOSER THAN 3/8 IN. FROM EDGE

CASINGS



1-800-861-0734 • FAX 1-800-861-0737

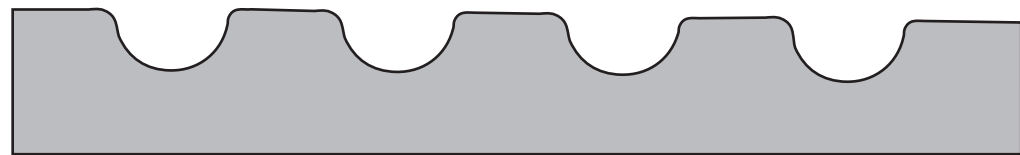

CNF525
3/4 X 5 1/4 in.

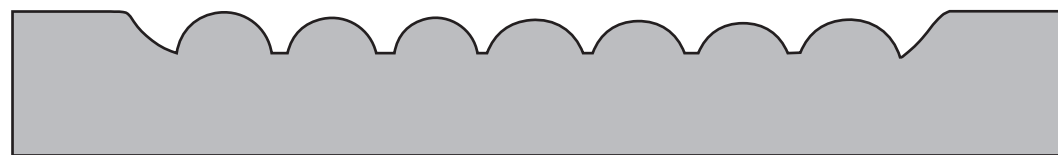

C606R
1 1/16 X 5 1/2 in.



SM75
3/4 X 5 1/2 in.



SM85
3/4 X 5 1/4 in.



C606F
1 1/16 X 5 1/2 in.



SM5806
3/4 X 5 1/2 in.

CASINGS



Many more profiles available, call... 1-800-861-0734 • FAX 1-800-861-0737



C600R
1 1/16 X 3 1/2 in.



CM14R
1 1/16 X 3 1/4 in.

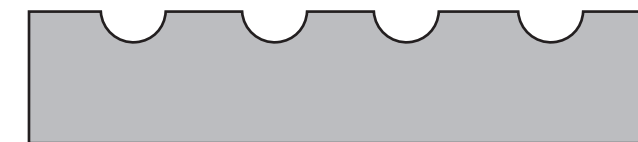

CM14F
1 1/16 X 3 1/4 in.



PT338F
5/8 X 3 3/8 in.



PT338R
5/8 X 3 3/8 in.



CCC350
3/4 X 3 7/16 in.



1002
9/16 X 3 9/16 in.



1002M
1/2 X 2 1/4 in.



CNF312
3/4 X 3 7/16 in.



SM8
3/4 X 5 in.

CASINGS

1-800-861-0734 • FAX 1-800-861-0737



SM12
15/16 X 4 1/2 in.

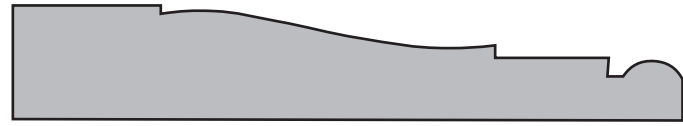

CM445A
11/16 X 3 1/2 in.

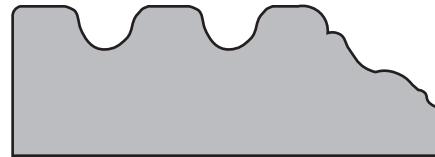

CFC 214, 3/4 X 2 1/4 in.
Also Available:
CFC 315, 3/4 X 3 1/2 in.
CFC 425, 3/4 X 4 1/4 in.

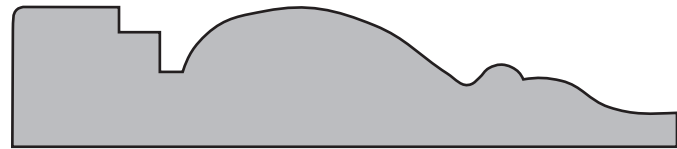

24112 PCA
3/4 X 3 1/2 in.



2814
1 1/4 X 4 5/8 in.

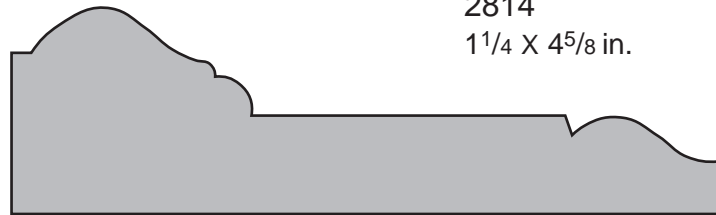

CM460
1 1/16 X 3 11/16 in.



CM371
1 1/16 X 3 in.

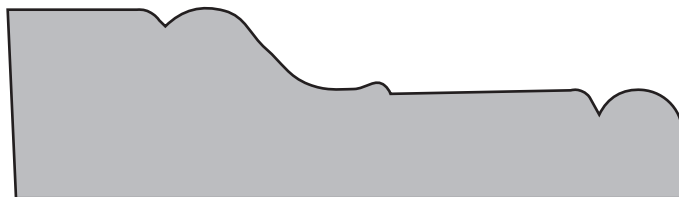

MD2
1 X 3 1/2 in.



NH234
7/8 X 2 3/4 in.

CASINGS

Many more profiles available, call... 1-800-861-0734 • FAX 1-800-861-0737

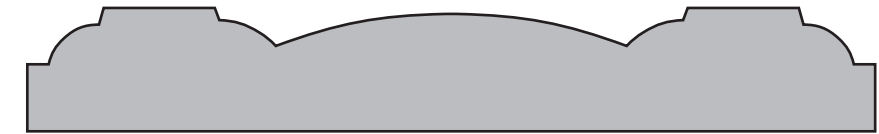

SM7
1 1/16 X 4 1/2 in.

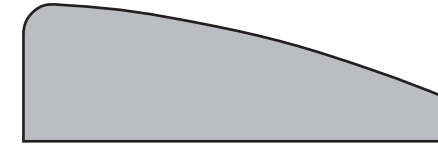

CM327
1 1/16 X 2 1/4 in.

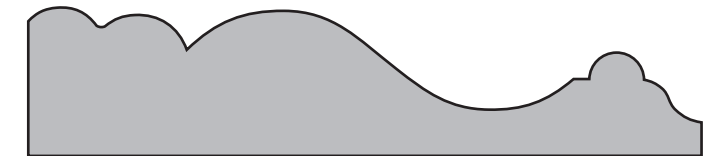

CKR350
3/4 X 3 1/2 in.

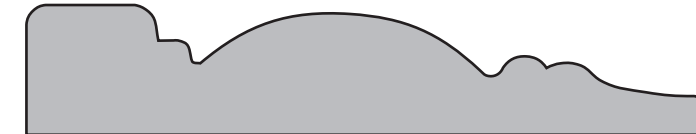

PM719
1 1/16 X 3 1/2 in.



WM351
1 1/16 X 2 1/2 in.



CBG275
3/4 X 2 3/4 in.

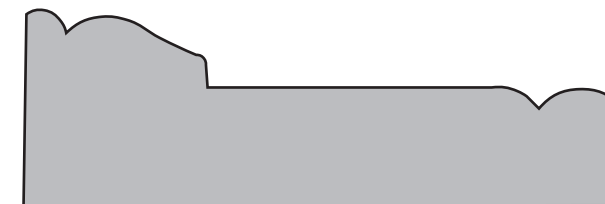

RIDOUT 376
1 in. X 3 in.

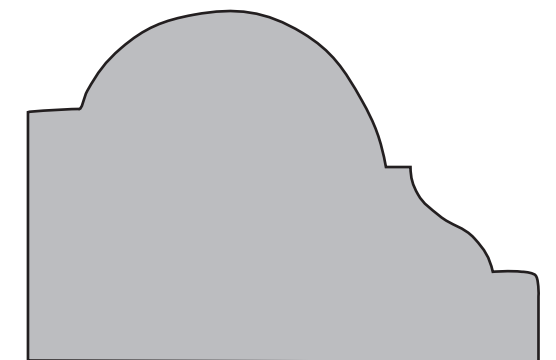

CAS50
1 3/4 X 2 1/2 in.



CKN425
3/4 X 4 1/4 in.

CASINGS

1-800-861-0734 • FAX 1-800-861-0737

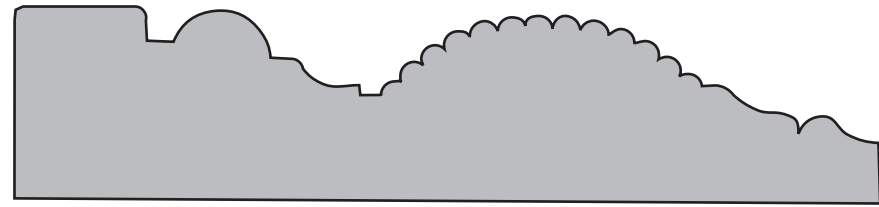

LSM2060
1¹/₁₆ X 4¹/₂ in.

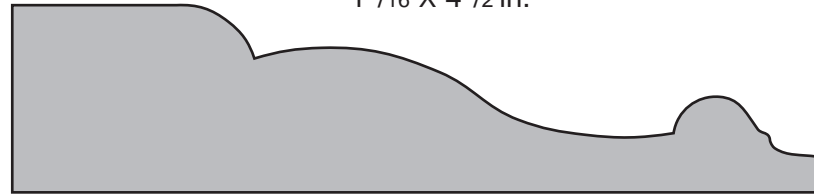

BM1188
1 X 4¹/₄ in.

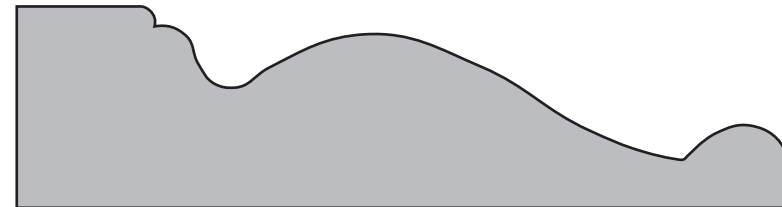

CN400
1 X 4 in.

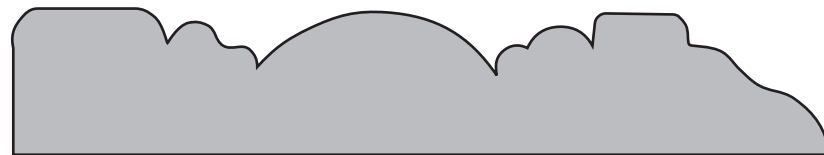

CBG400
3/4 X 4¹/₄ in.

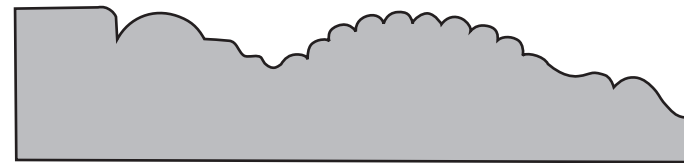

CRC350
3/4 X 3¹/₂ in.



CRC425
3/4 X 4¹/₂ in.

CASINGS

Many more profiles available, call... 1-800-861-0734 • FAX 1-800-861-0737



CGA425
1 X 4¹/₄ in.

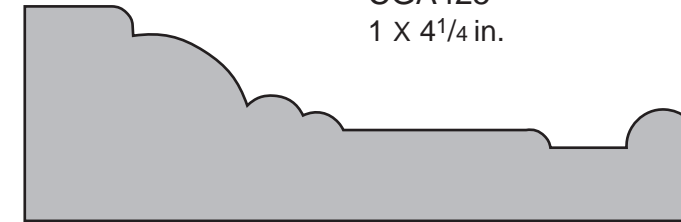

COXCOMB
1¹/₁₆ X 3¹/₂ in.

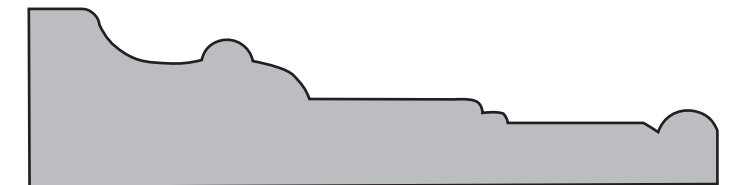

NH358
7/8 X 3⁵/₈ in.

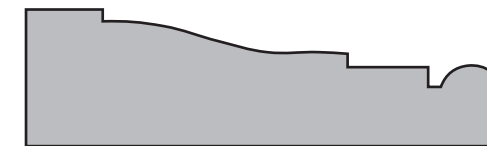

WM371
1¹/₁₆ X 2¹/₂ in.

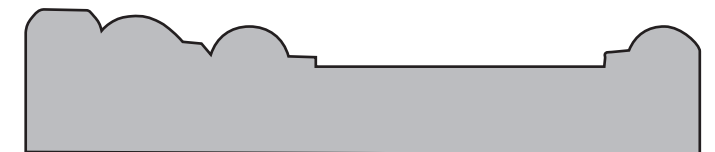

CKN350
3/4 X 3¹/₂ in.

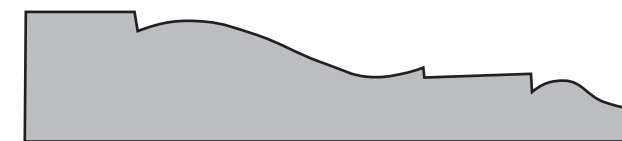

CM361
1¹/₁₆ X 3¹/₄ in.

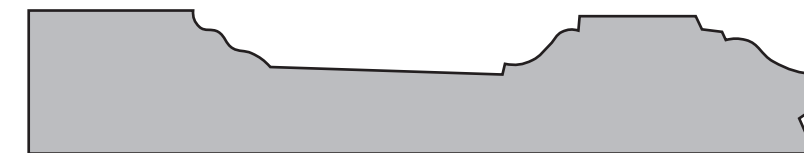

SM83
3/4 X 4¹/₈ in.

CASINGS



1-800-861-0734 • FAX 1-800-861-0737

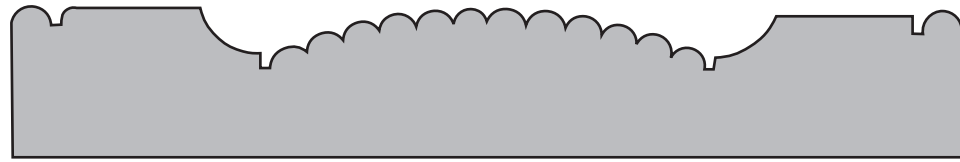

SM80
3/4 X 5 in.

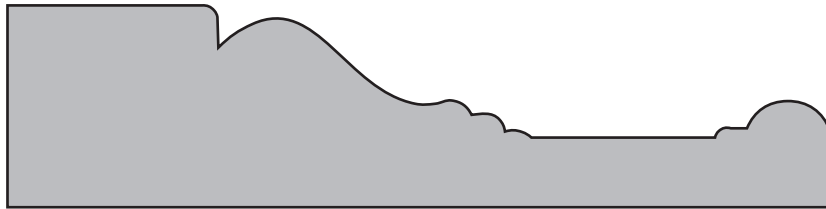

CJF425
1 X 4 1/4 in.



LWM 97
3/4 X 3 1/2 in.

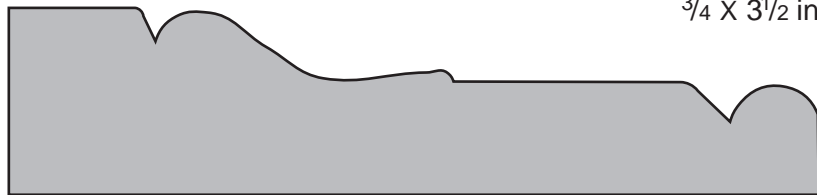

C425
1 X 4 1/4 in.

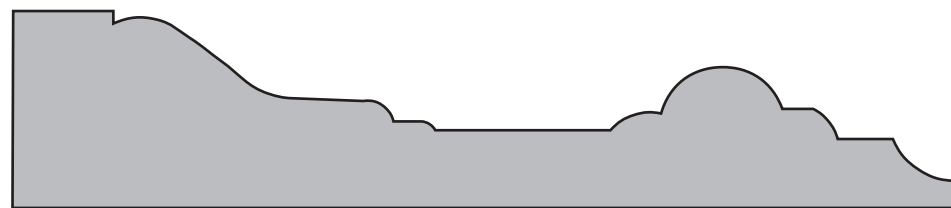

MISS JENNY
1 1/16 X 4 7/8 in.

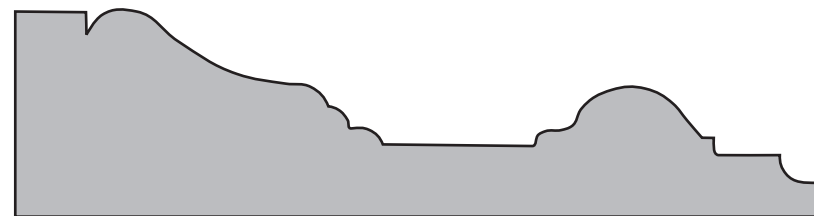

CAG425
1 1/16 X 4 1/4 in.

CASINGS



Many more profiles available, call... 1-800-861-0734 • FAX 1-800-861-0737



CM433
9/16 X 3 1/4 in.



CM473
9/16 X 2 1/4 in.

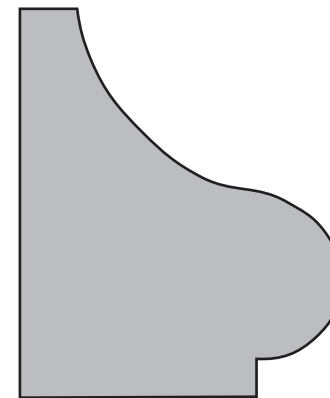

CAS30
1 3/4 X 2 in.



CM452
1 1/16 X 2 1/2 in.



SM2050
1 1/16 X 4 1/2 in.

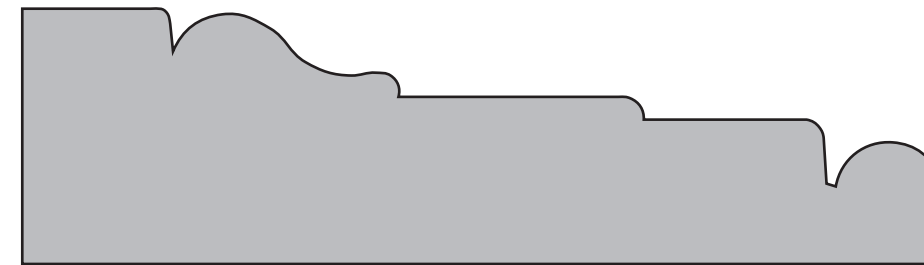

BM995
1 5/16 X 4 3/4 in.

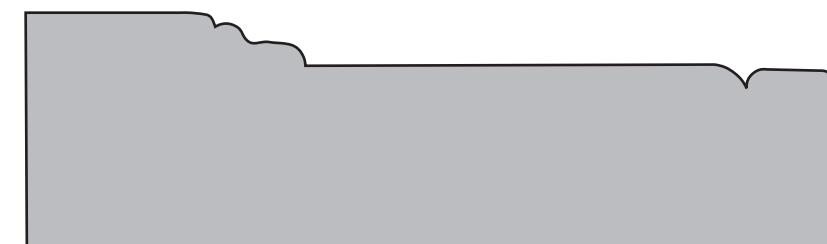

SM 5701
1 1/4 X 4 1/2 in.

CASINGS



1-800-861-0734 • FAX 1-800-861-0737

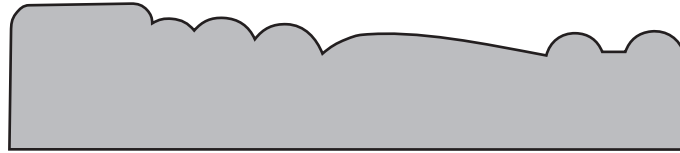

CAM350
3/4 X 3 1/2 in.

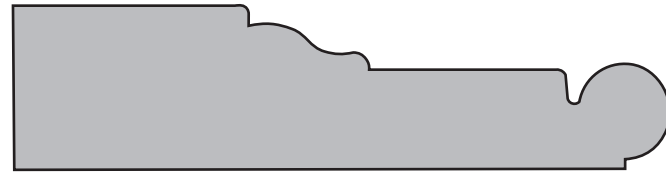

BM1455
7/8 X 4 3/32 in.

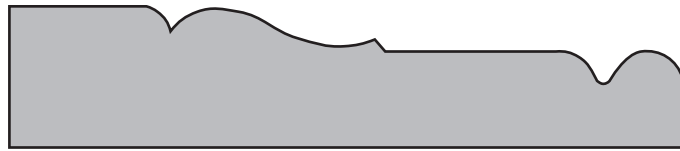

C352
3/4 X 3 1/2 in.

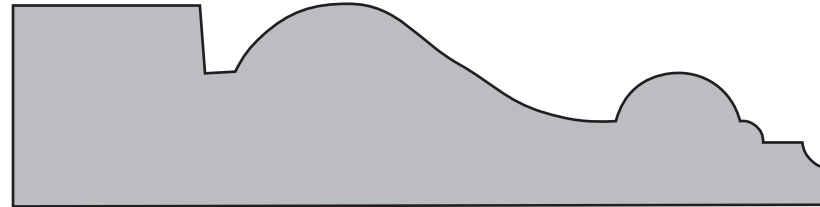

RBI SPR3
1 1/16 X 4 1/4 in.



BM255
1 3/16 X 3 15/16 in.

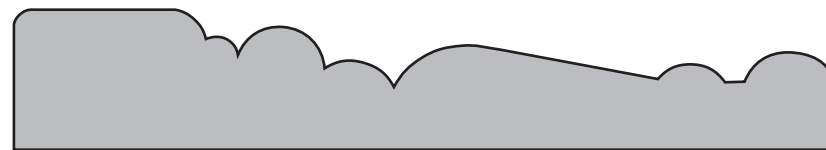

CAM400
3/4 X 4 1/4 in.

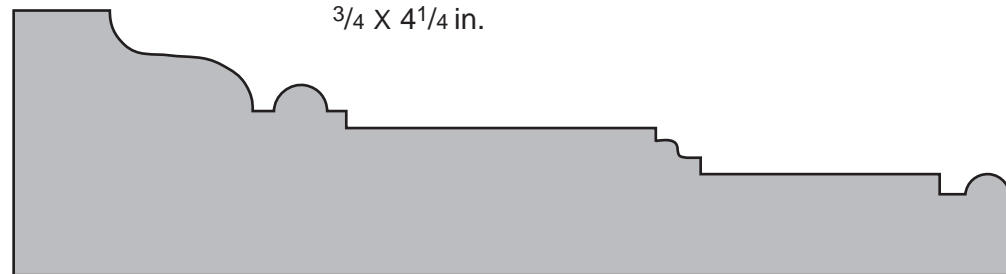

SM84
1 3/8 X 5 1/4 in.

CASINGS



Many more profiles available, call... 1-800-861-0734 • FAX 1-800-861-0737

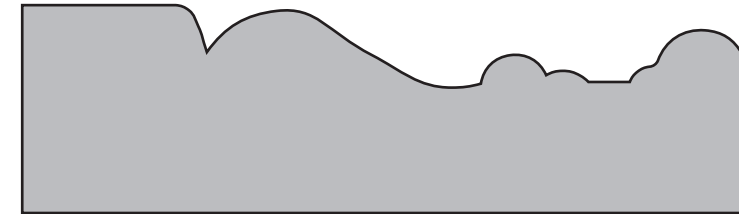

RBI208
1 1/16 X 3 3/4 in.



CTE350
3/4 X 3 1/2 in.



CM683
1 1/16 X 3 1/4 in.



TM1
1 1/16 X 3 1/4 in.

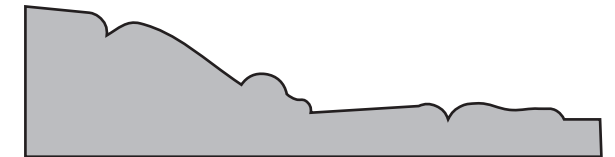

399
3/4 X 3 in.

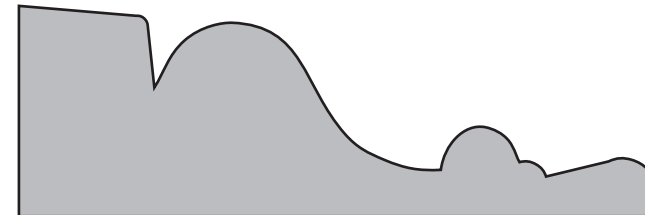

MS1661 SPROT LONG
1 1/8 X 3 3/8 in.

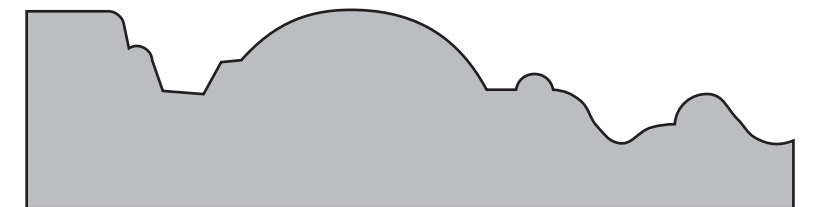

SM2051
1 X 4 in.

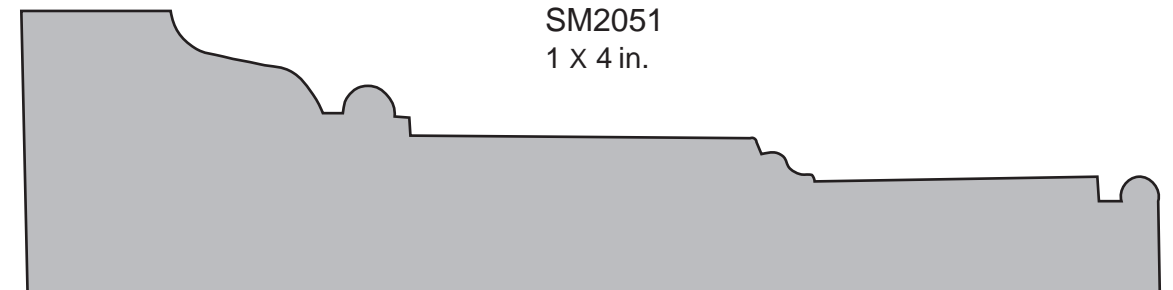

CW1 Also available: 1 7/16 X 4 in.
1 7/16 X 5 5/8 in.

CASINGS



1-800-861-0734 • FAX 1-800-861-0737

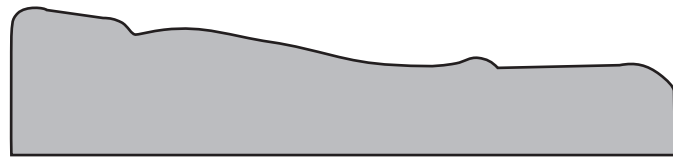

C351
3/4 X 3 1/2 in.



WM444
1 1/16 X 3 1/4 in.



LDFCA4
1 X 4 in.



CKN234
3/4 X 2 3/4 in.



SM82
1 1/16 X 2 3/4 in.

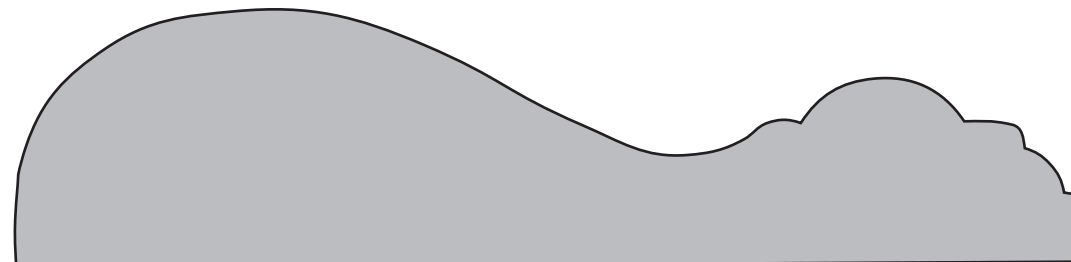

EC490
1 5/16 X 5 1/2 in.

CASINGS



Many more profiles available, call... 1-800-861-0734 • FAX 1-800-861-0737



CBG300
3/4 X 3 1/2 in.

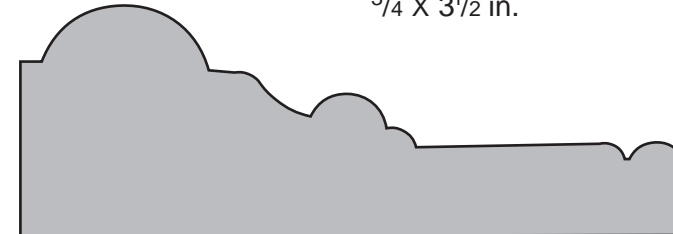

SM47
1 1/4 X 3 1/2 in.

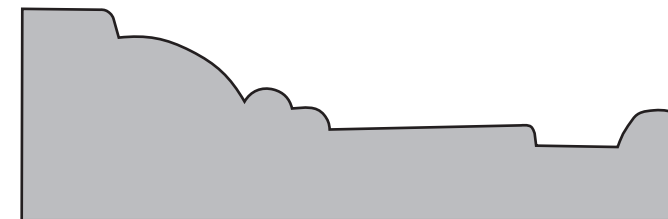

SM2
1 1/16 X 3 5/8 in.



PT312
5/8 X 3 in.

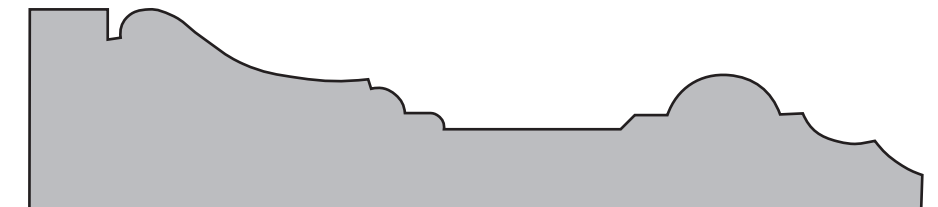

CM466
1 1/16 X 4 5/8 in.

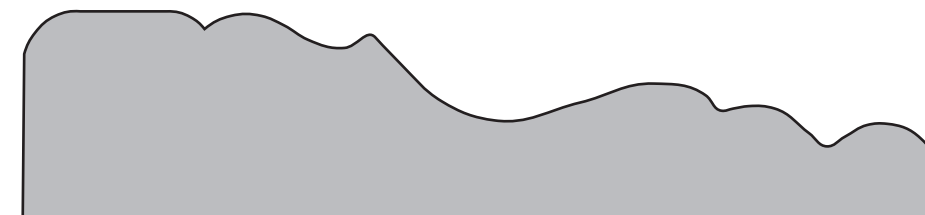

PRESIDENTIAL
1 1/16 X 4 3/4 in.

CASINGS



1-800-861-0734 • FAX 1-800-861-0737

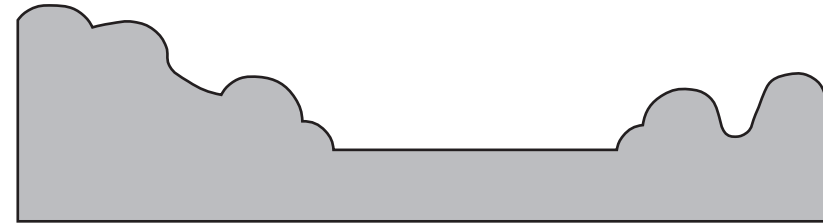

P LARGE HOWE
1 1/8 X 4 1/4 in.

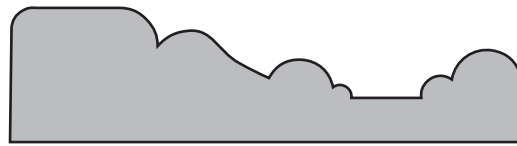

TMMH (Mini Howe)
1 1/16 X 2 3/4 in.

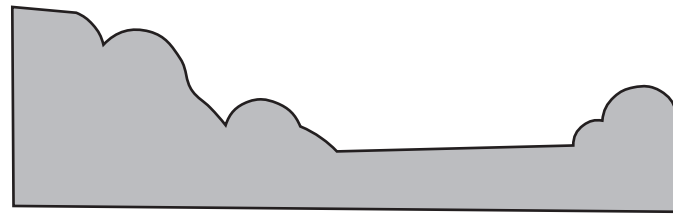

DELTA HOWE
1 X 3 7/16 in.

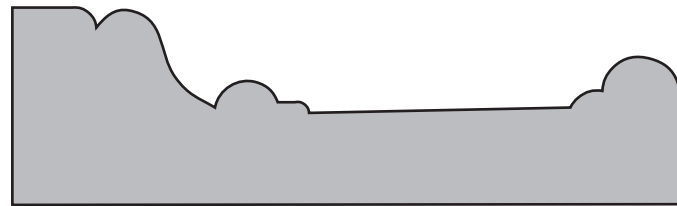

CKN535
1 X 3 1/2 in.



CM10
1 1/16 X 2 3/8 in.

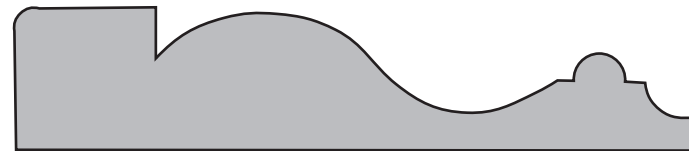

CVA350
3/4 X 3 1/2 in.

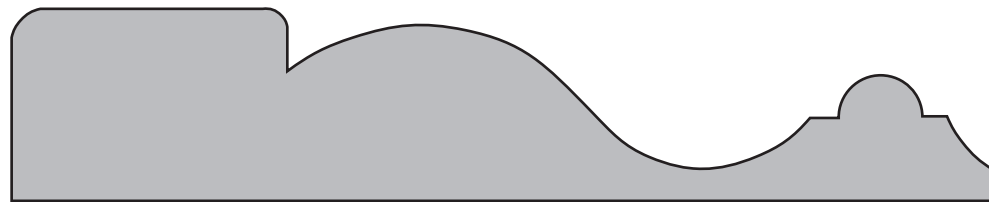

CVA525
1 X 5 1/4 in.

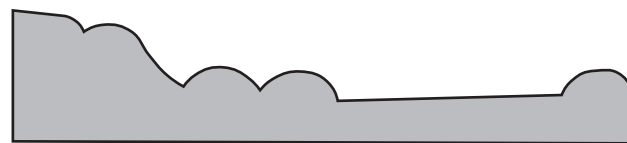

MSI1
1 1/16 X 3 1/4 in.

BACK BANDS



Many more profiles available, call... 1-800-861-0734 • FAX 1-800-861-0737

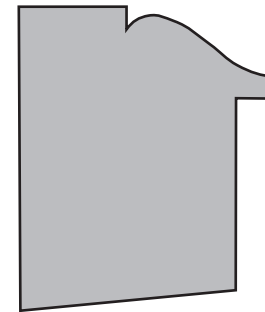

C282
1 5/16 X 1 5/8 in.

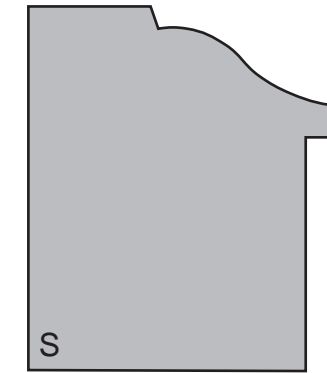

CM809
1 3/8 X 1 5/8 in.

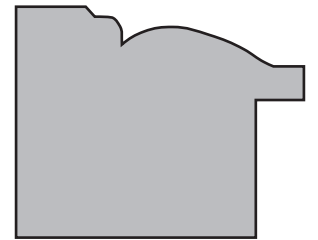

4046USBB
1 3/16 X 1 1/2 in.

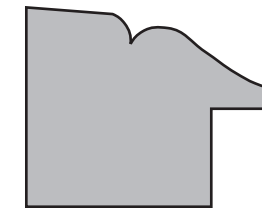

97BB
1 1/8 X 1 1/16 in.

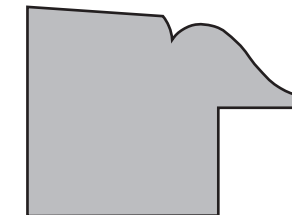

SM68
1 1/16 X 1 7/16 in.

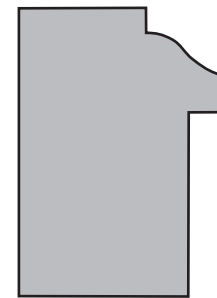

BR285
1 1/8 X 1 1/2 in.

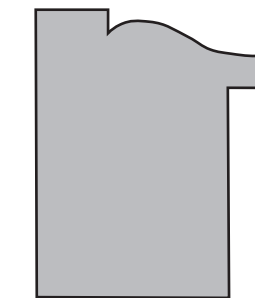

4048US-BB
1 1/4 X 1 1/2 in.

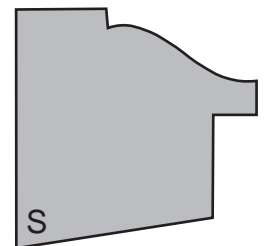

C281
1 5/16 X 1 5/16 in.

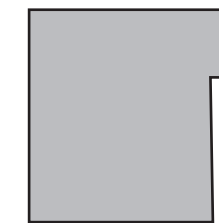

3436BB
1 1/16 X 1 1/8 in.

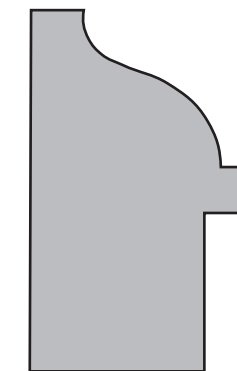

SM2513
1 1/8 X 1 7/8 in.

BACK BANDS

1-800-861-0734 • FAX 1-800-861-0737

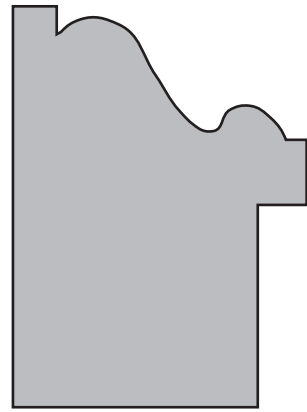

SM2501-2
1⁹/₁₆ X 2¹/₈ in.

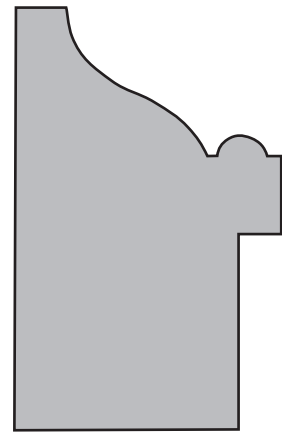

BB200
1¹/₂ X 2³/₈ in.

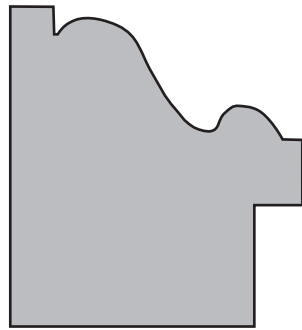

SM2501
1⁹/₁₆ X 1¹¹/₁₆ in.

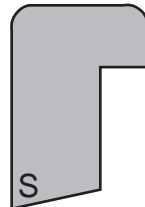

CM280
1¹/₁₆ X 1¹/₁₆ in.

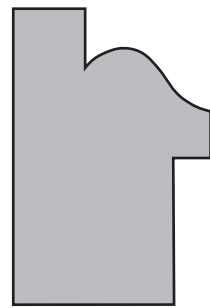

SM2510
1¹/₁₆ X 1¹/₂ in.

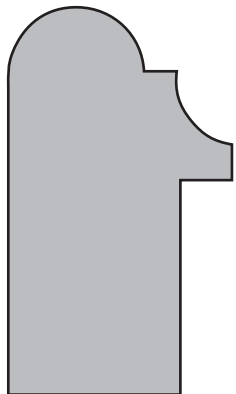

SM2511-2
1³/₁₆ X 2 in.

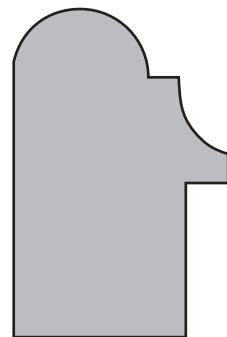

SM2511
1³/₁₆ X 1³/₄ in.

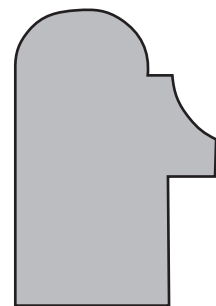

CM289
1¹/₁₆ X 1⁹/₁₆ in.

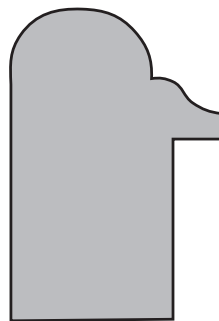

CRC150
1 X 1⁵/₈ in.
Also Available:
5/8 Rabbett
1¹/₁₆ Rabbett

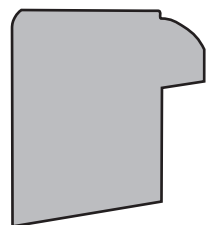

GP281
1 X 1¹/₈ in.



CM281
1¹/₁₆ X 1¹/₈ in.

CROWN

Many more profiles available, call... 1-800-861-0734 • FAX 1-800-861-0737

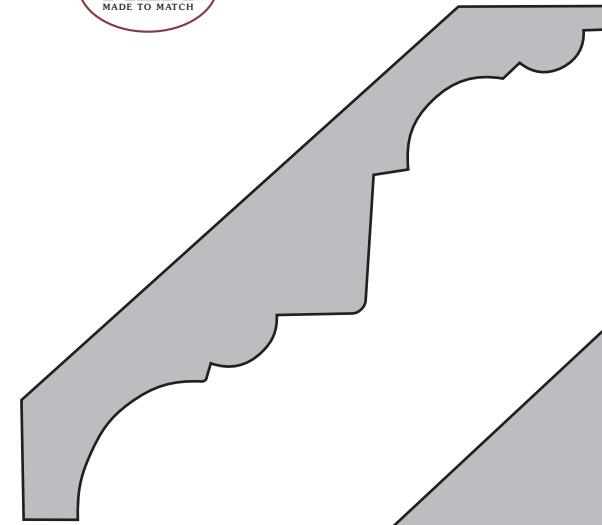

SM27
7/8 X 4¹/₈ in.

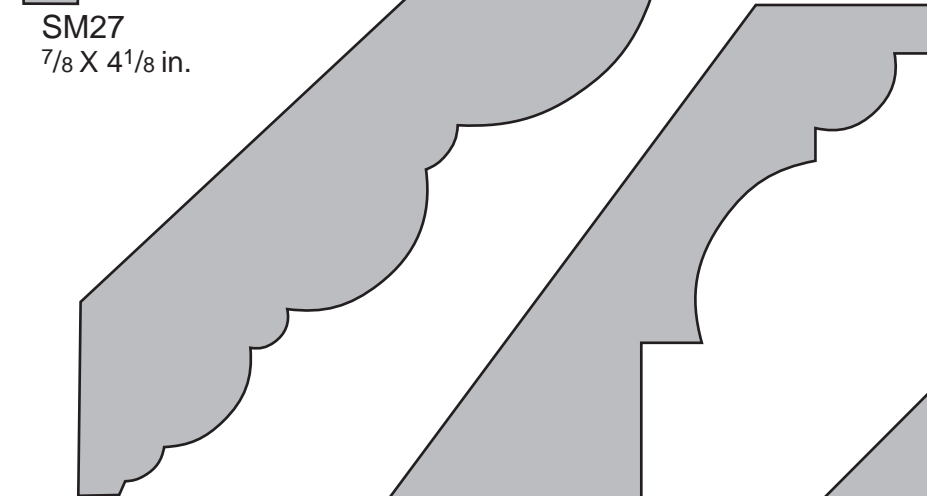

SM603
1 X 7¹/₄ in.

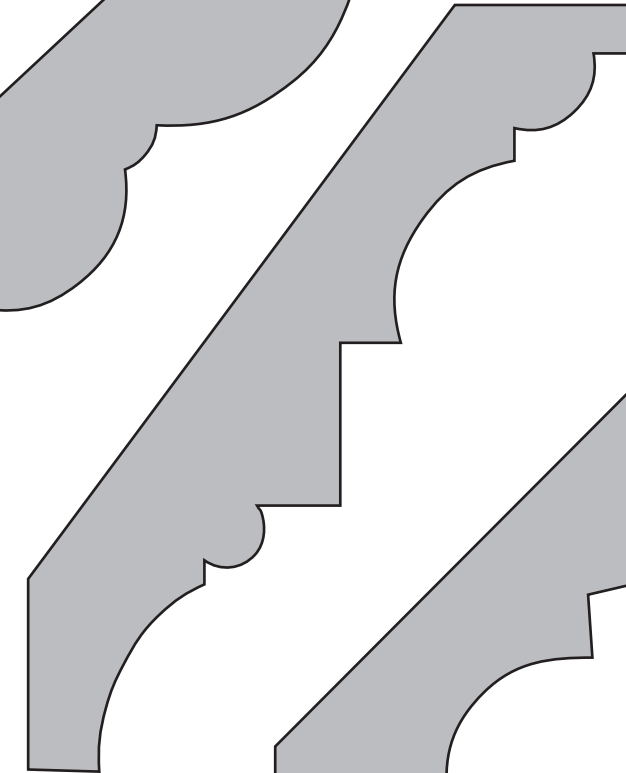

SM29
1¹¹/₁₆ X 5¹/₈ in.

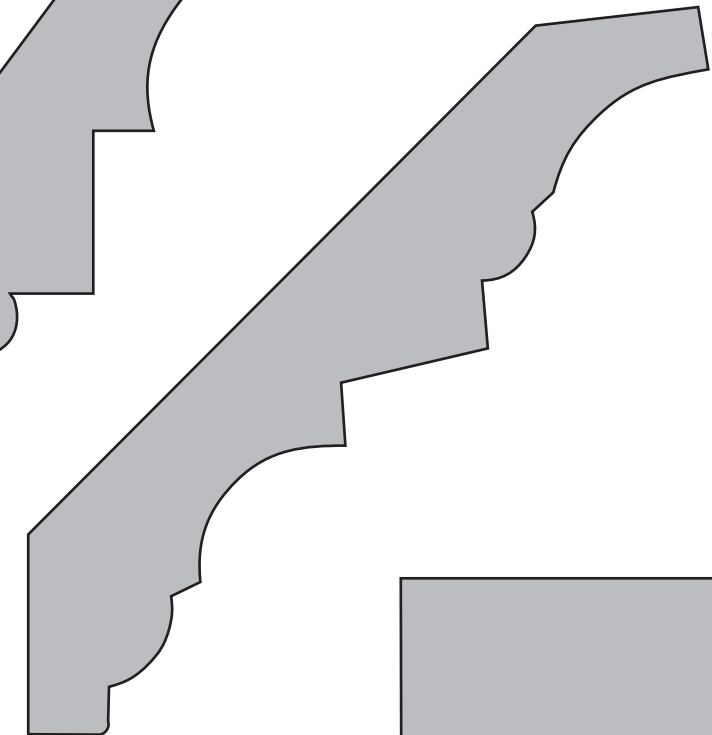

BM6
1 X 6³/₄ in.



SM42
2¹/₄ X 1⁵/₈ in.

CROWN



1-800-861-0734 • FAX 1-800-861-0737

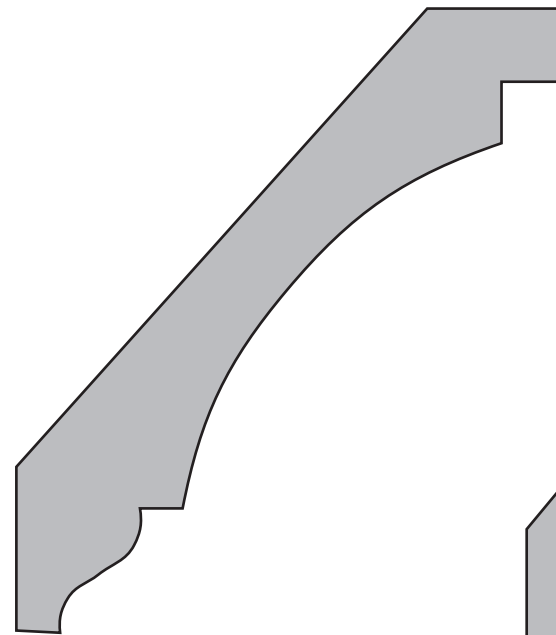

AH40
1¹/₁₆ X 4¹/₄ in.

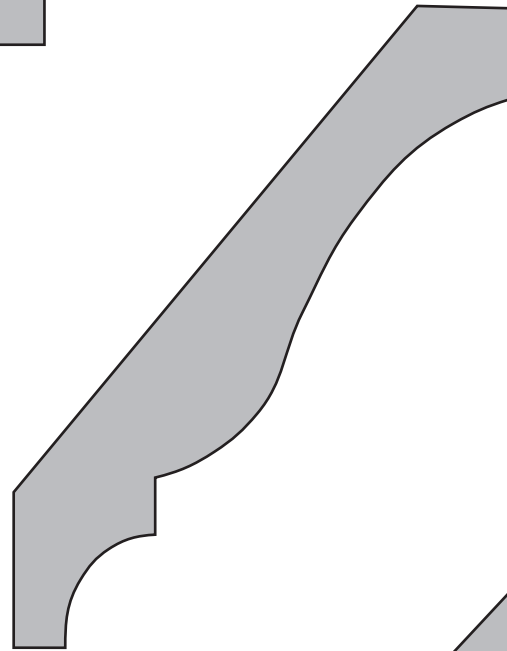

CM48
9⁹/₁₆ X 4¹/₄ in.

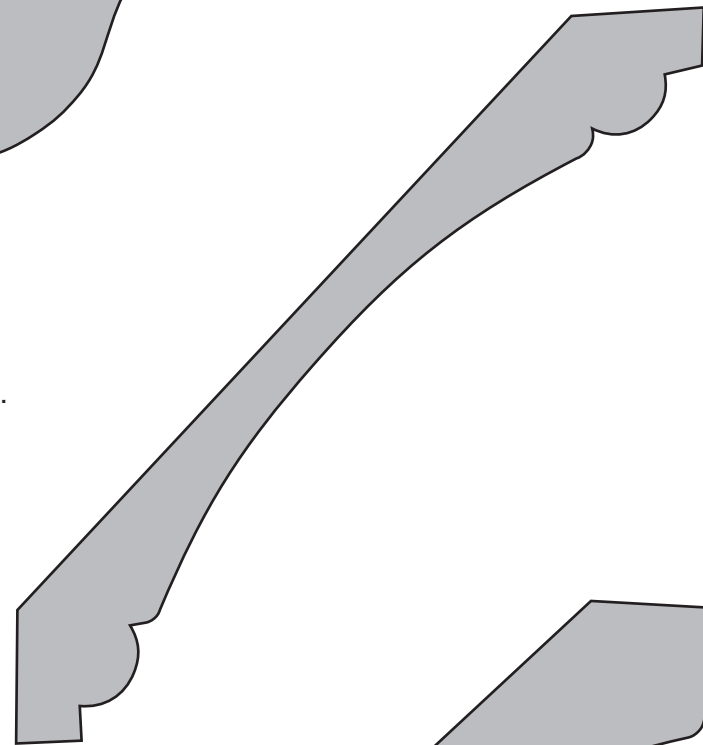

CM541
1¹/₁₆ X 5¹/₄ in.

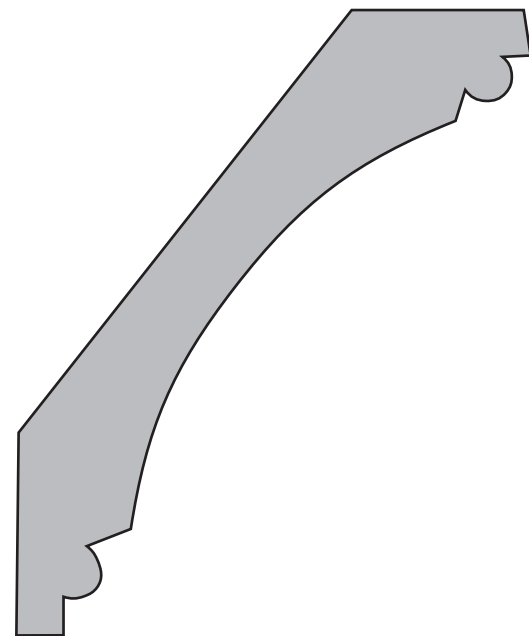

WM80
1¹/₁₆ X 4¹/₄ in.



COLONIAL COVE
3³/₄ X 5¹/₄ in.

CROWN



Many more profiles available, call... 1-800-861-0734 • FAX 1-800-861-0737

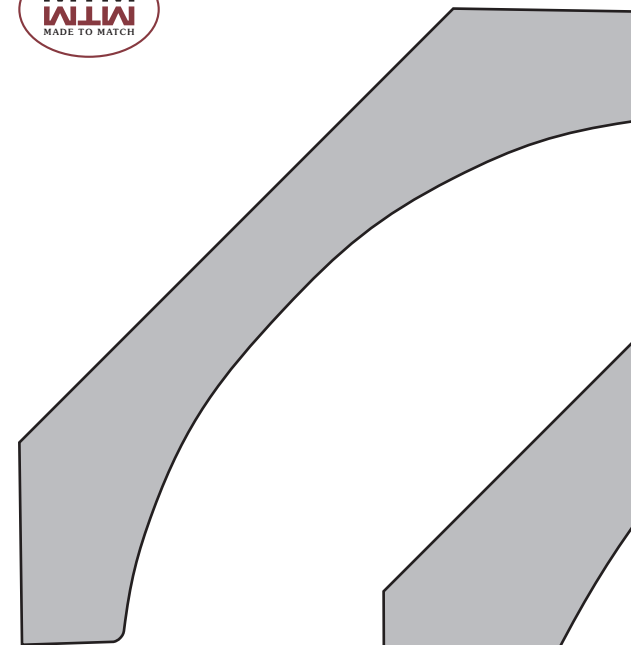

SM81
1¹/₁₆ X 4⁵/₈ in.
Also Available:
SM86
1¹/₂ X 6 in

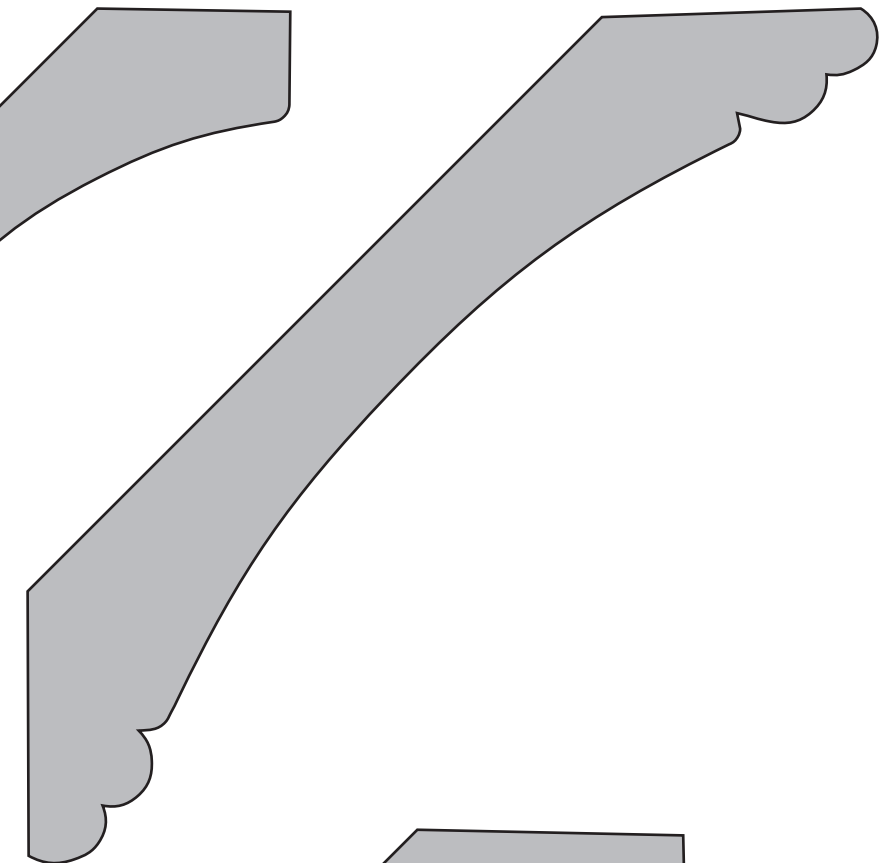

RBCCM625
1 X 6¹/₄ in.

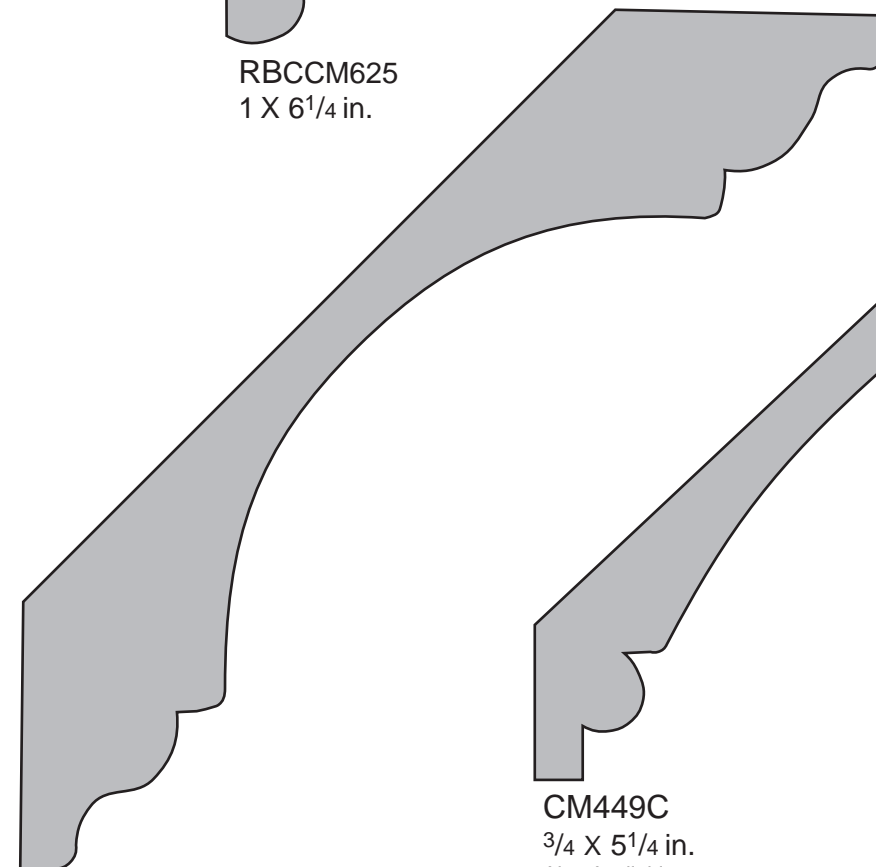

TP41/TLC500
1¹/₈ X 6¹/₄ in.

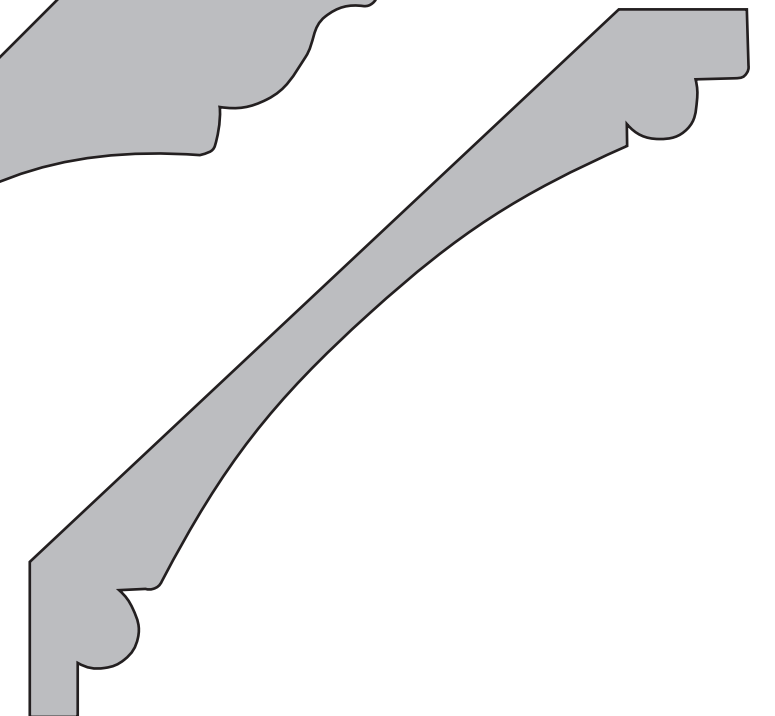

CM449C
3³/₄ X 5¹/₄ in.
Also Available:
CM6449C
3³/₄ X 6¹/₄ in.

CROWN



1-800-861-0734 • FAX 1-800-861-0737

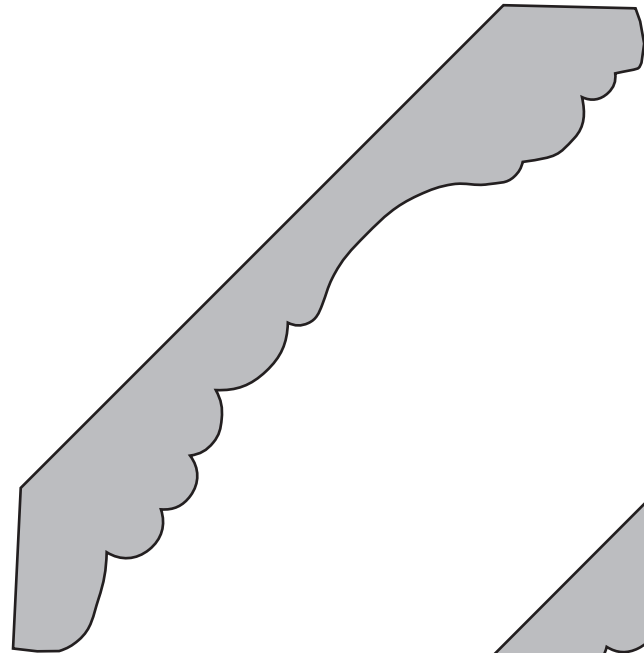

SM1136
3/4 X 4 7/8 in.

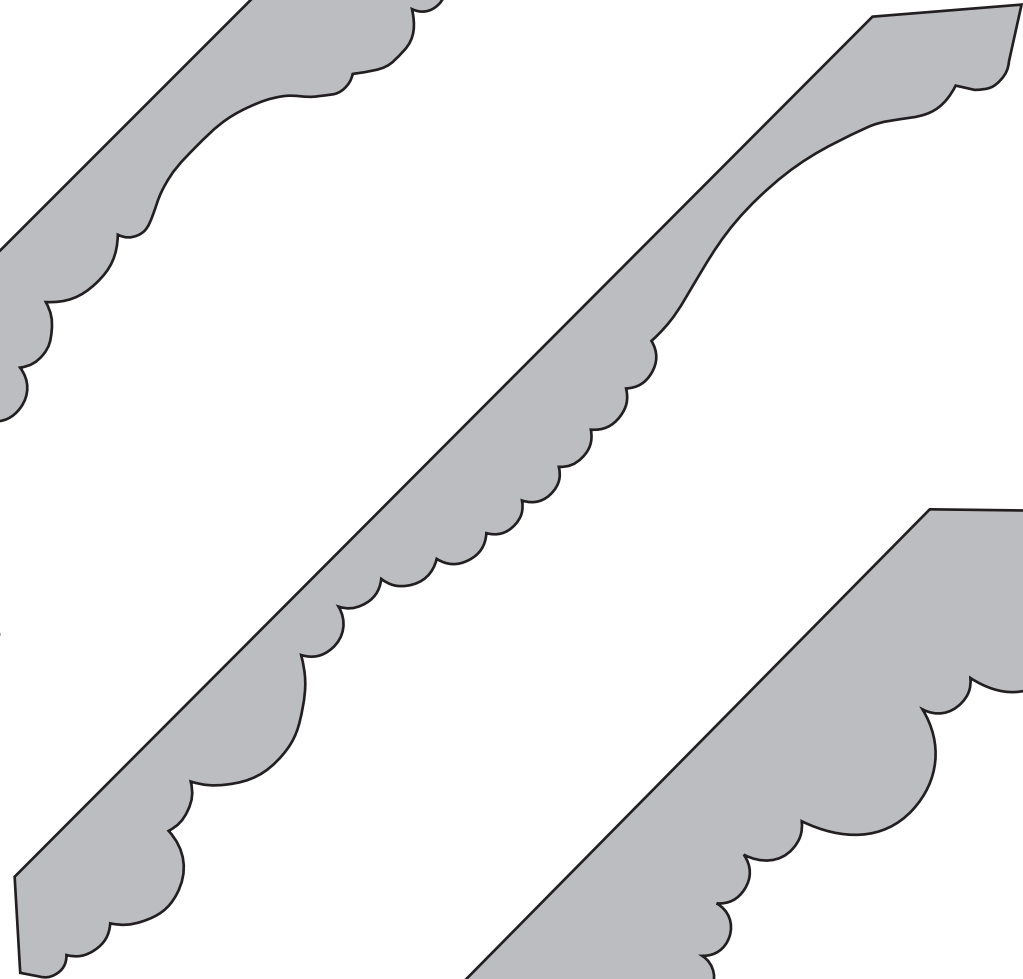

BBS725
1 1/16 X 7 1/4 in.

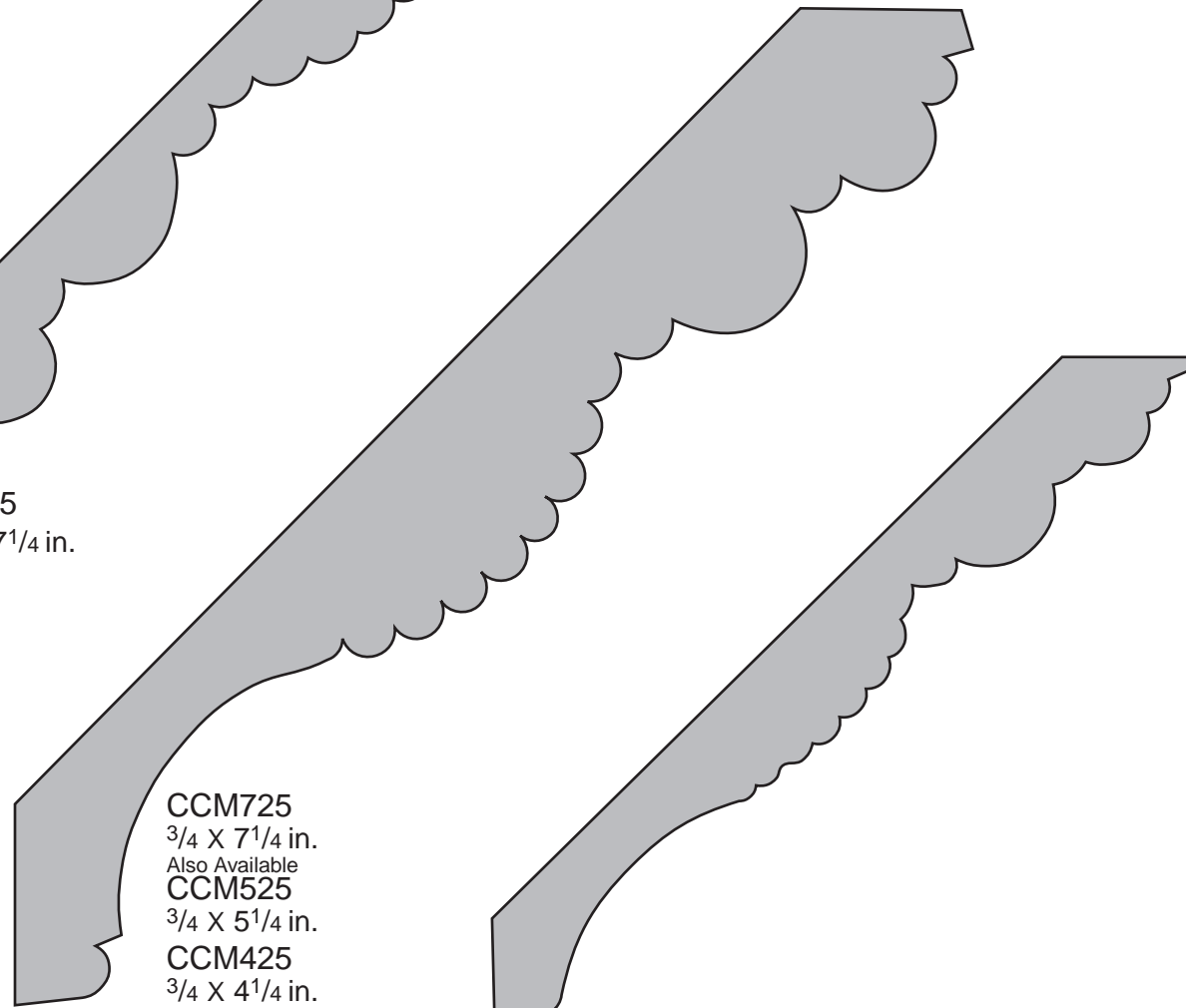

CCM725
3/4 X 7 1/4 in.
Also Available
CCM525
3/4 X 5 1/4 in.
CCM425
3/4 X 4 1/4 in.

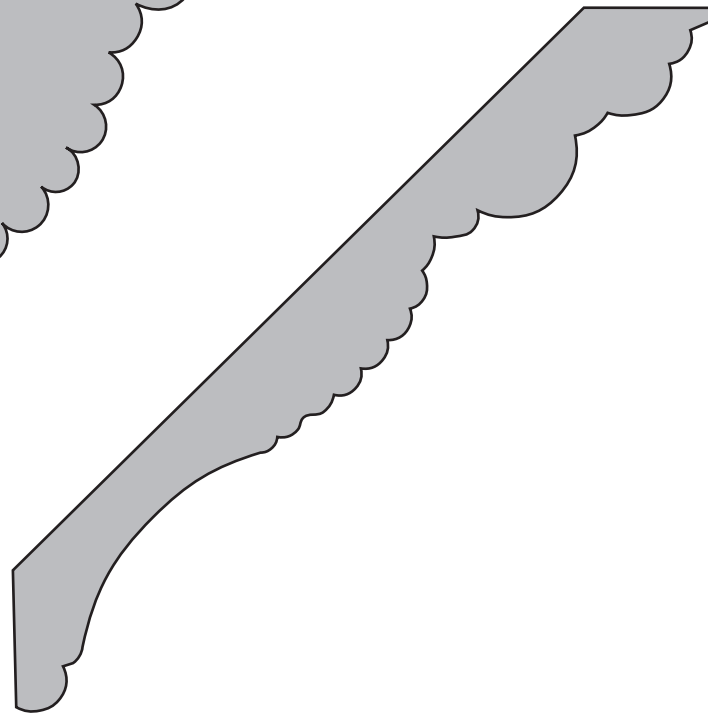

BBS111
3/4 X 5 1/4 in.

CROWN



Many more profiles available, call... 1-800-861-0734 • FAX 1-800-861-0737

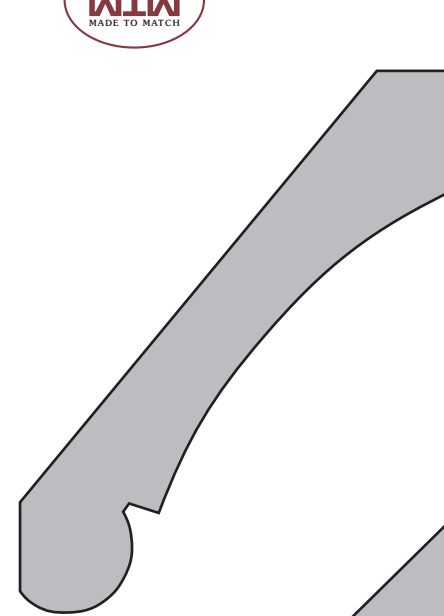

SM21
1 1/16 X 3 1/2 in.

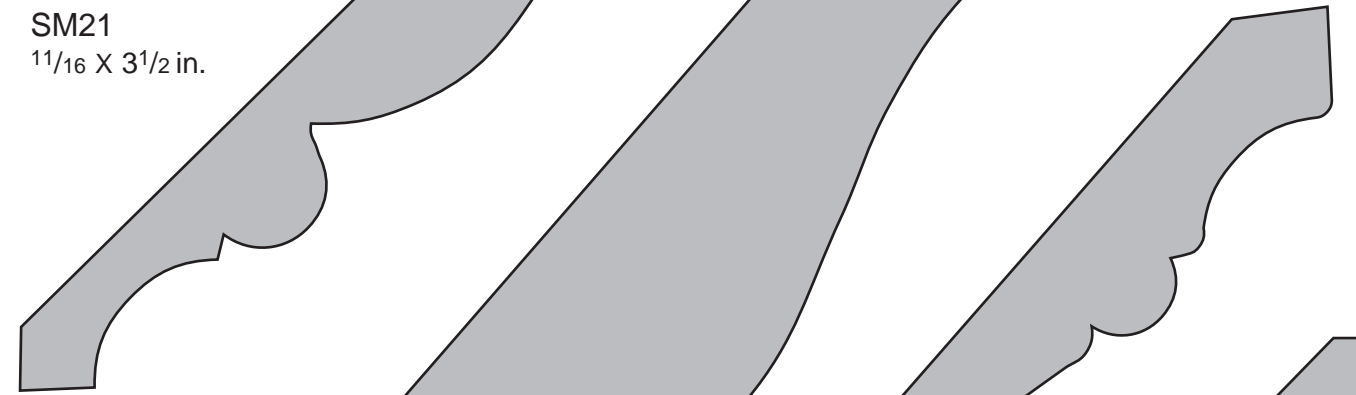

EC36
1 1/16 X 7 1/4 in.

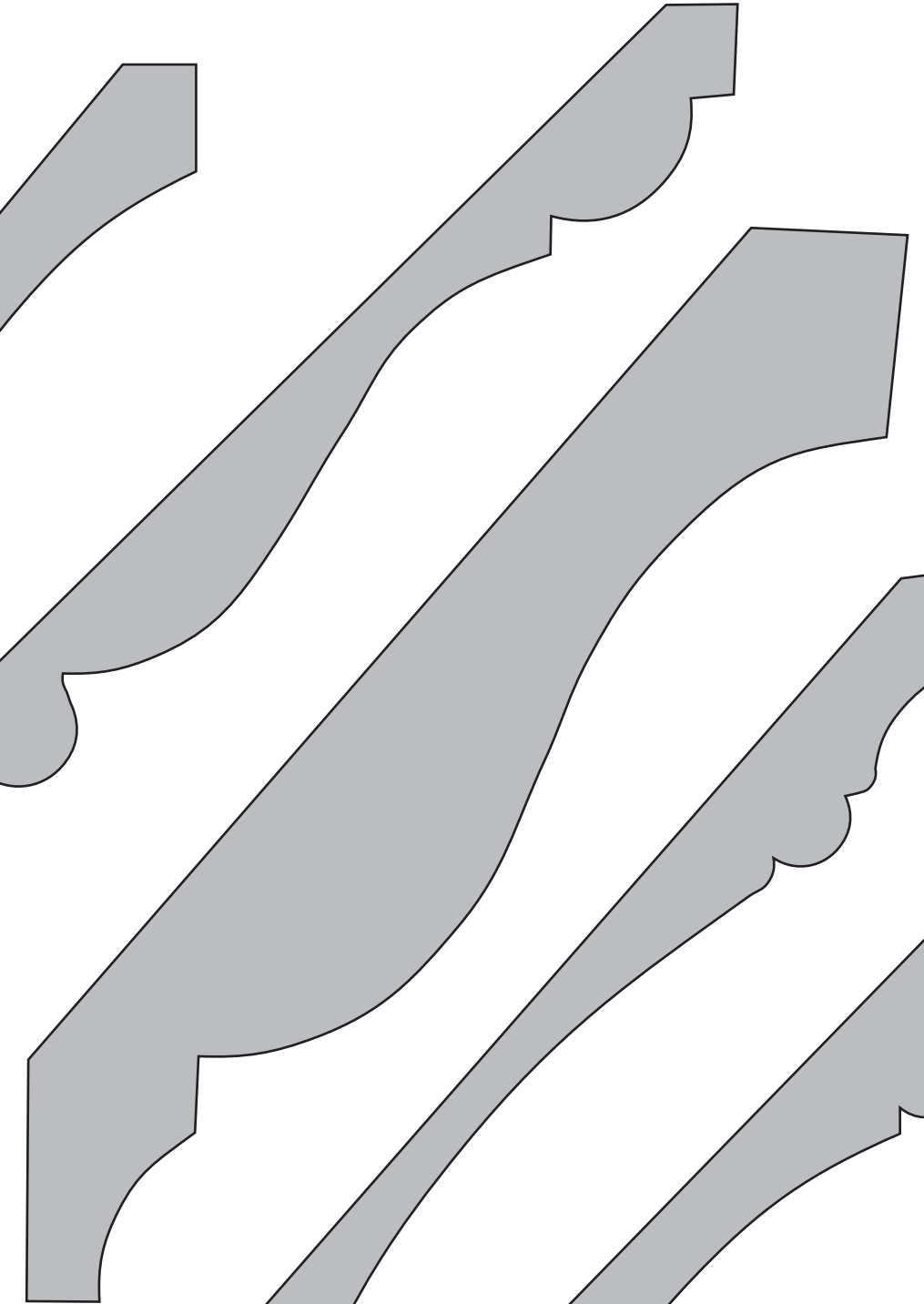

SM38
1 3/8 X 8

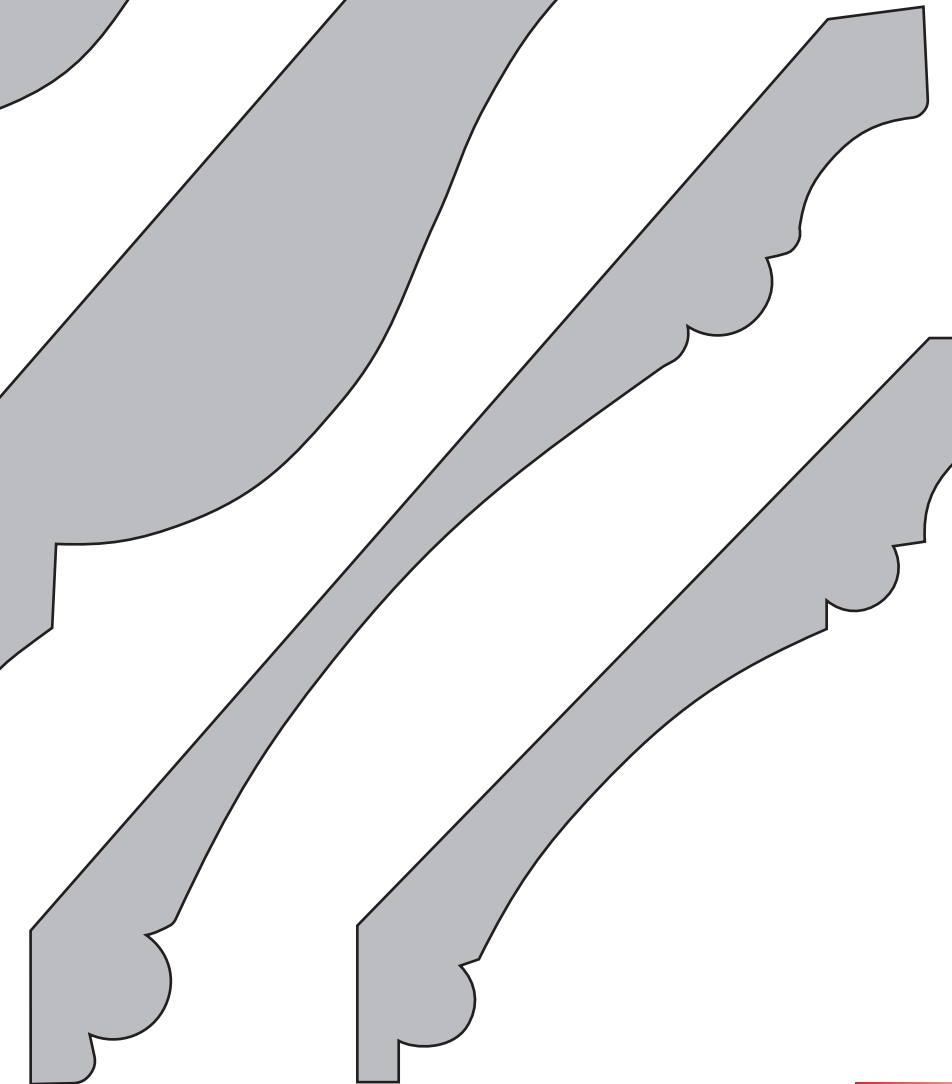

CM725L
3/4 X 7 1/4 in.

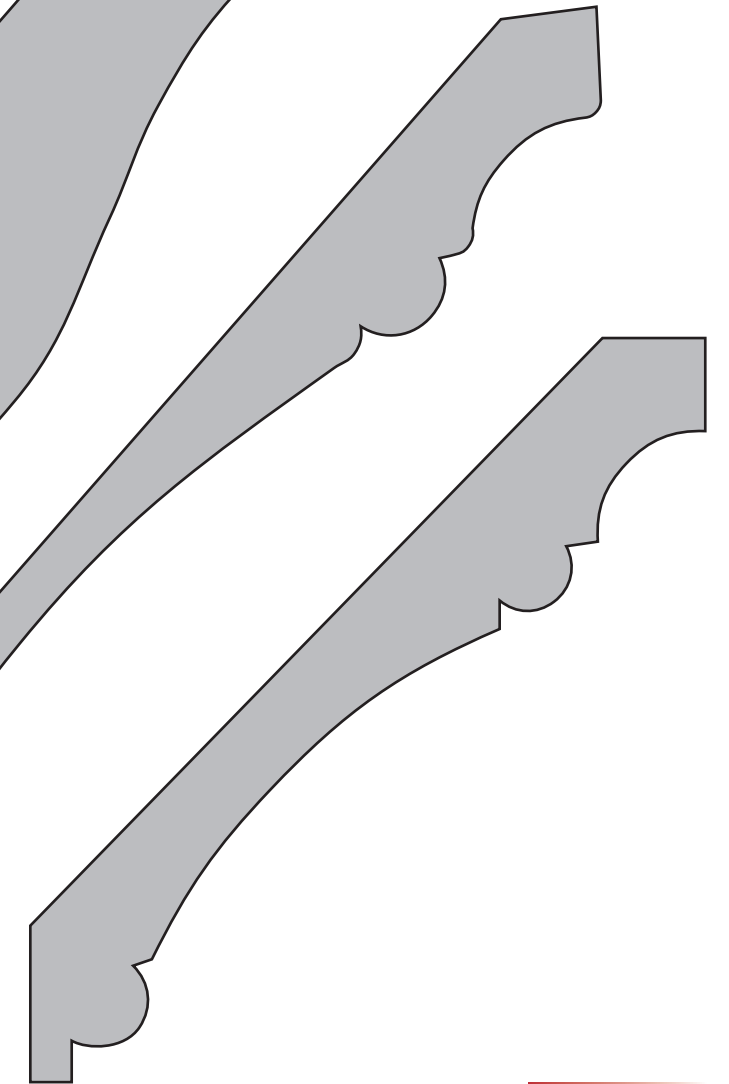

CM525L
3/4 X 5 1/4 in.

CROWN



1-800-861-0734 • FAX 1-800-861-0737

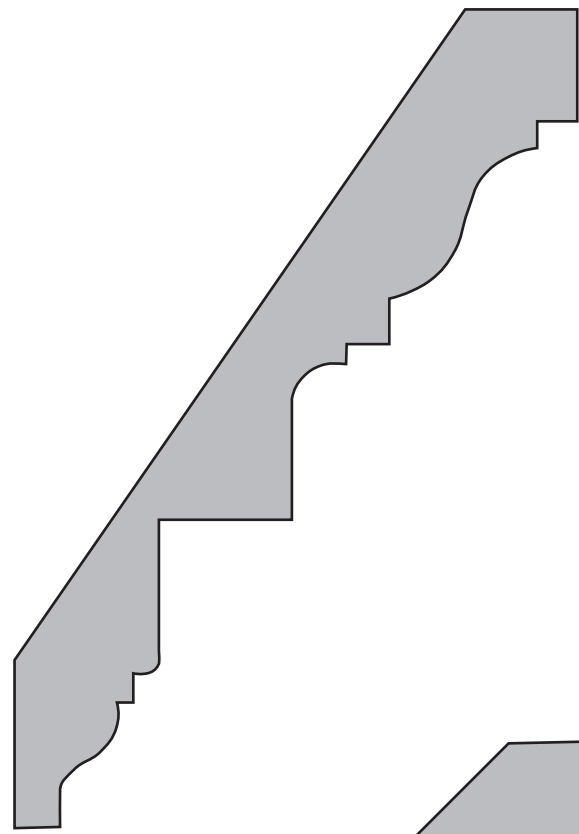

SM32
3/4 X 5 1/4 in.

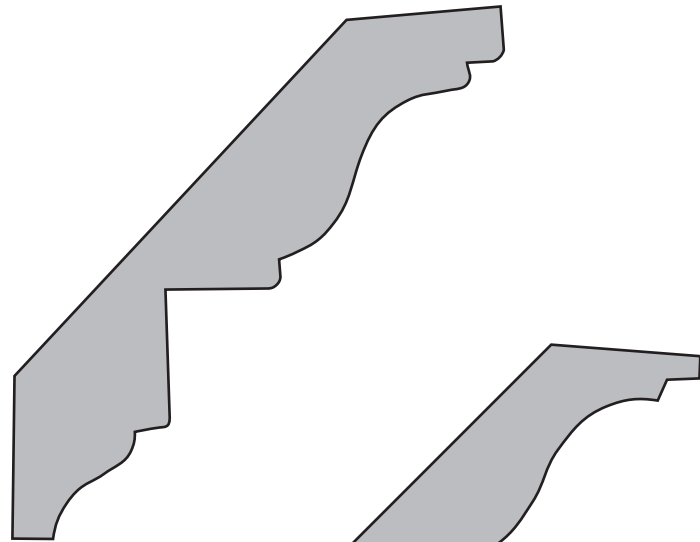

CM375L
3/4 X 3 1/4 in.

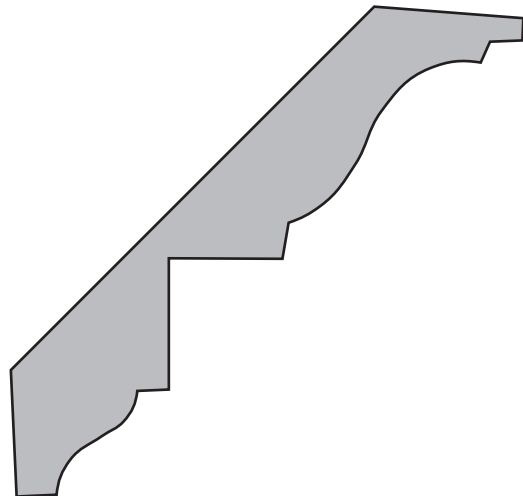

RB4
5/8 X 3 1/2 in.

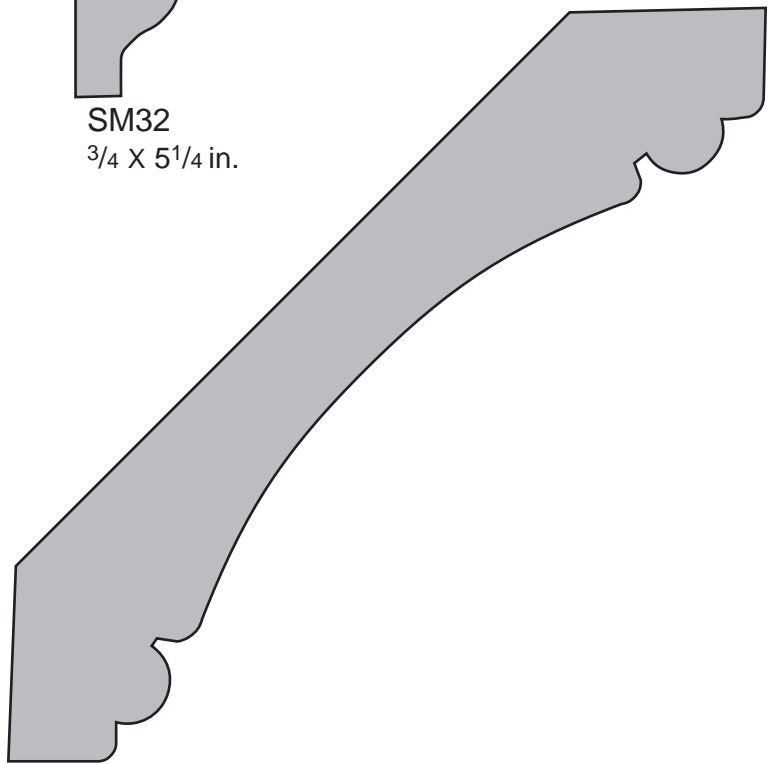

BM51245
15/16 X 5 1/2 in.

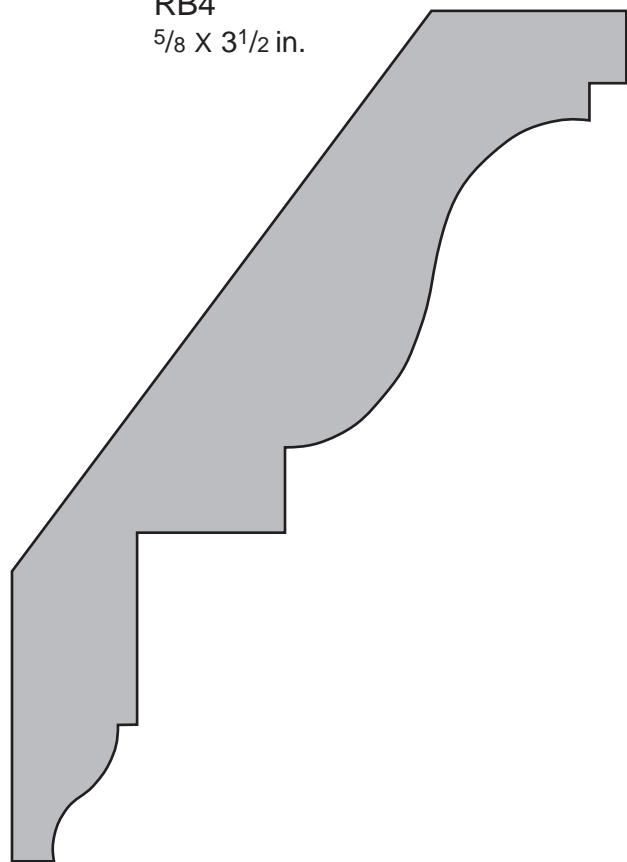

RB7
1 1/16 X 5 1/4 in.

CROWN



Many more profiles available, call... 1-800-861-0734 • FAX 1-800-861-0737

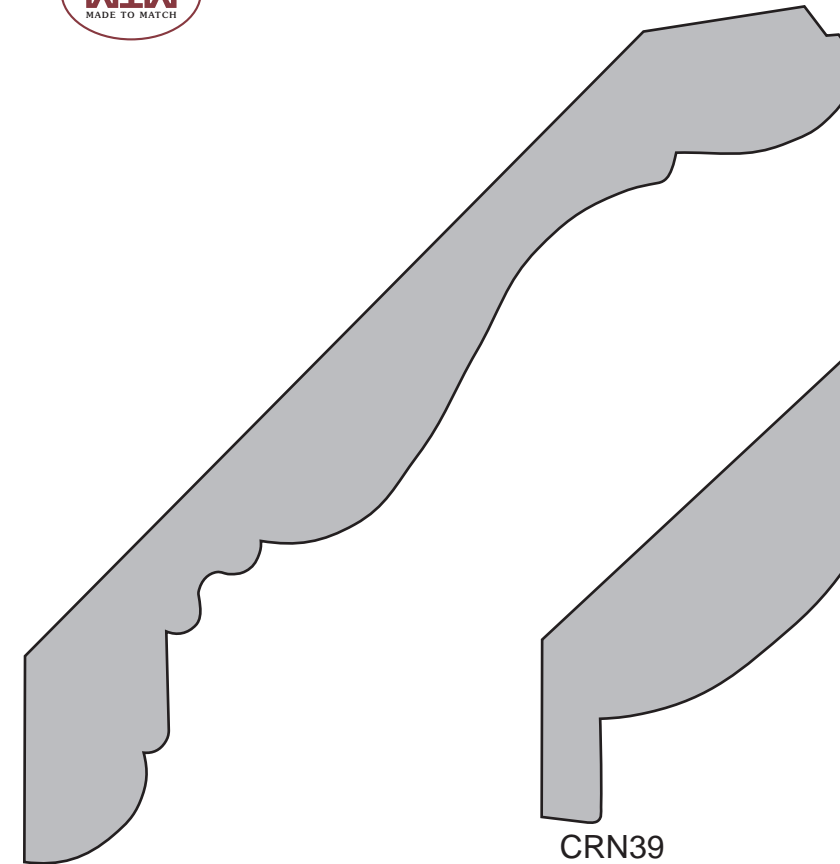

AH61
1 X 6 in.

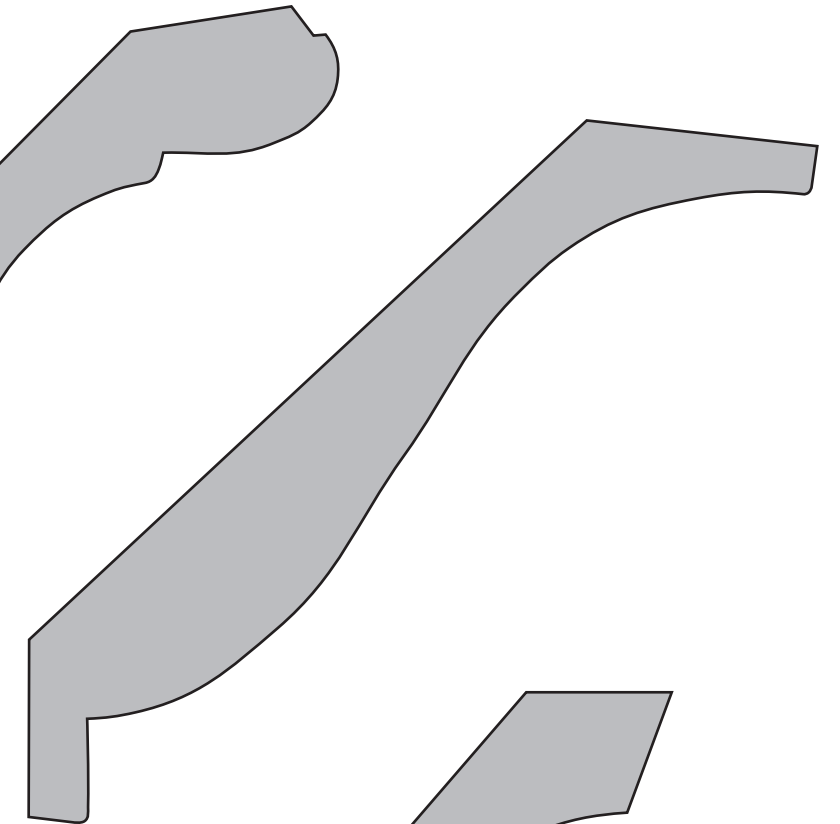

CRN39
1 X 5 1/4 in.

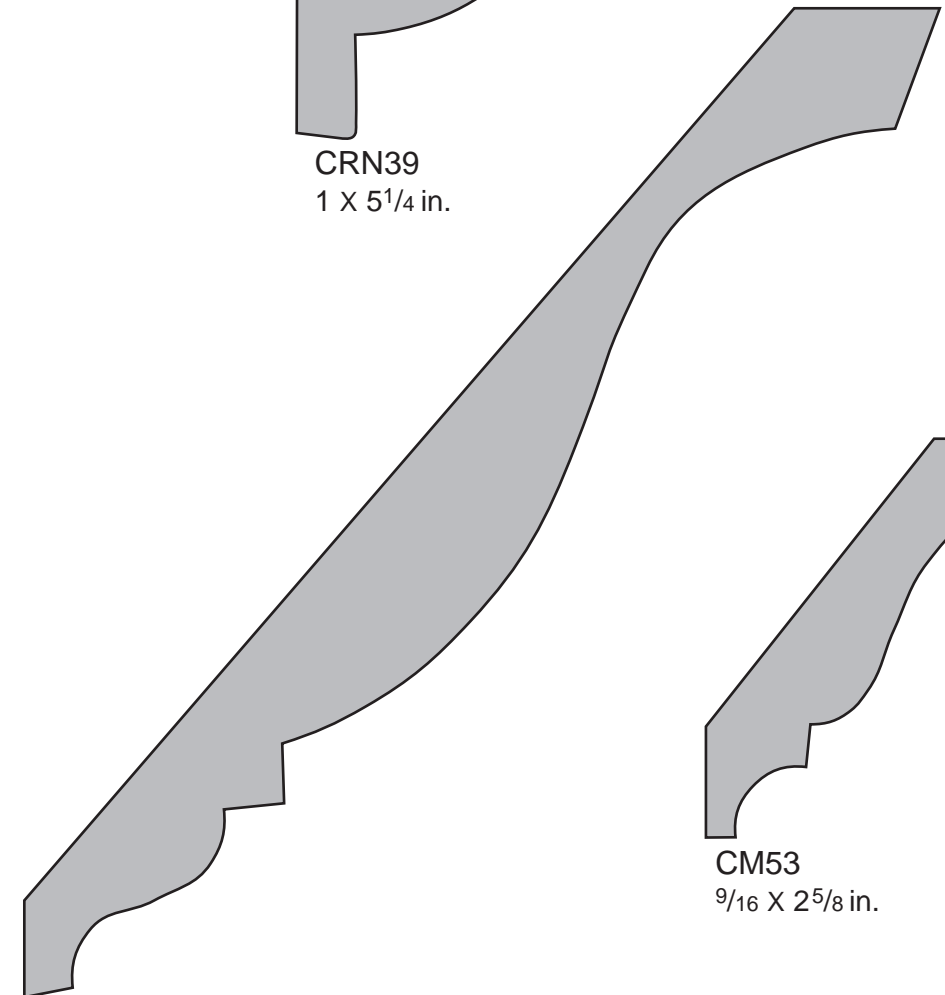

CM70(COX)
3/4 X 7 1/4 in.

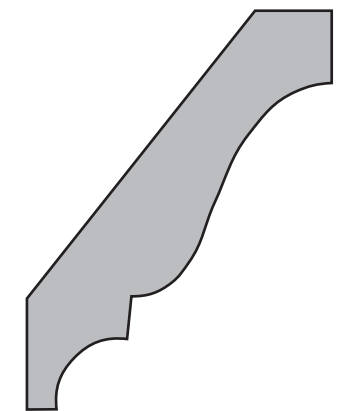

CM53
9/16 X 2 5/8 in.

CROWN



1-800-861-0734 • FAX 1-800-861-0737

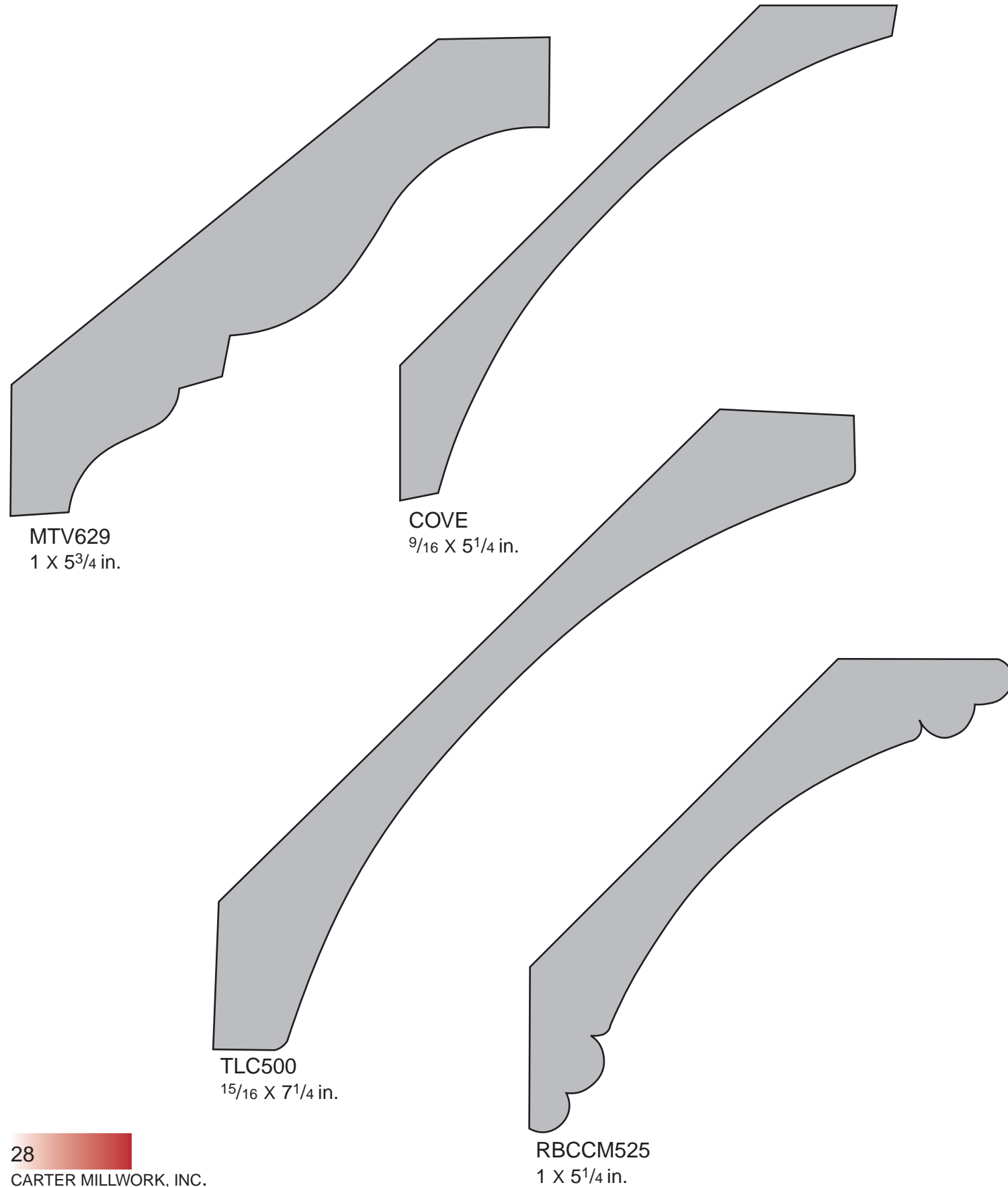

CROWN



Many more profiles available, call... 1-800-861-0734 • FAX 1-800-861-0737

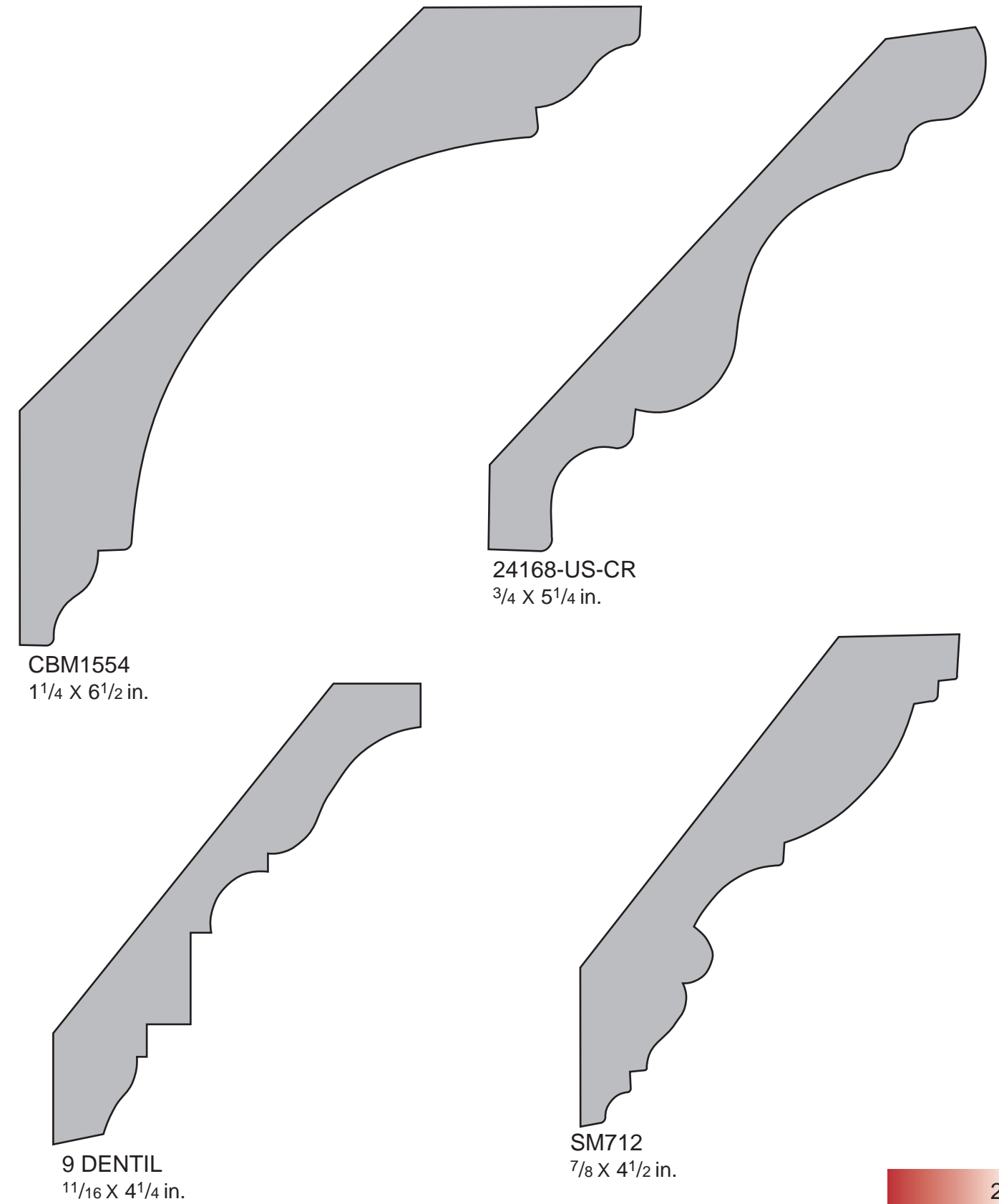

CROWN



1-800-861-0734 • FAX 1-800-861-0737

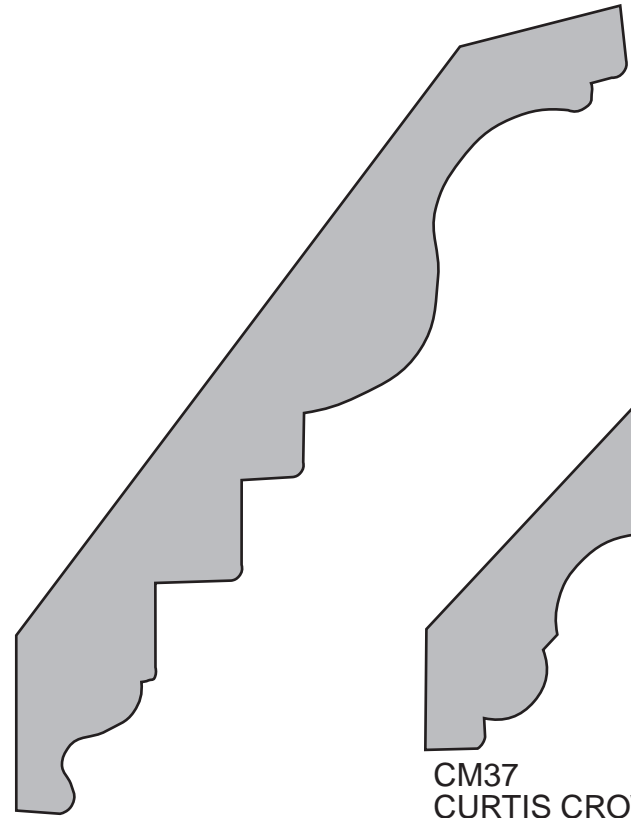

CM549
3/4 X 5 1/4 in.

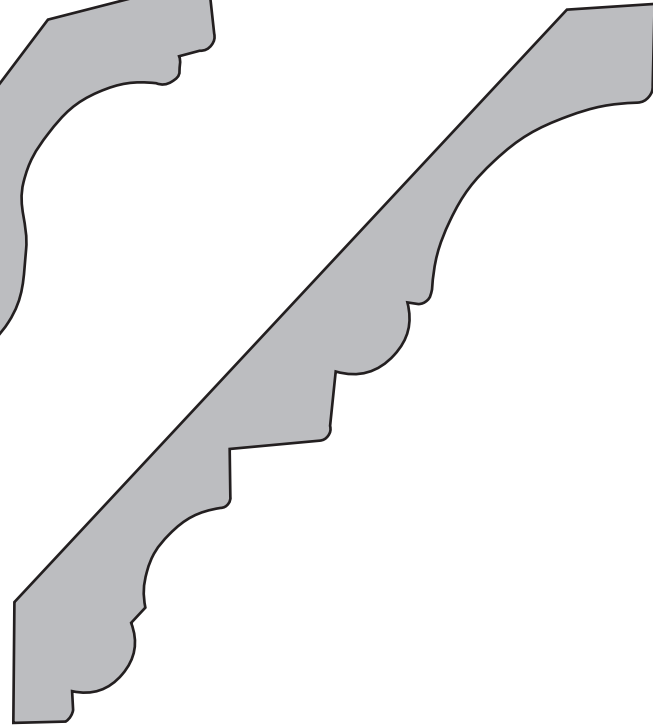

CM37
CURTIS CROWN
1 1/16 X 5 1/16 in.

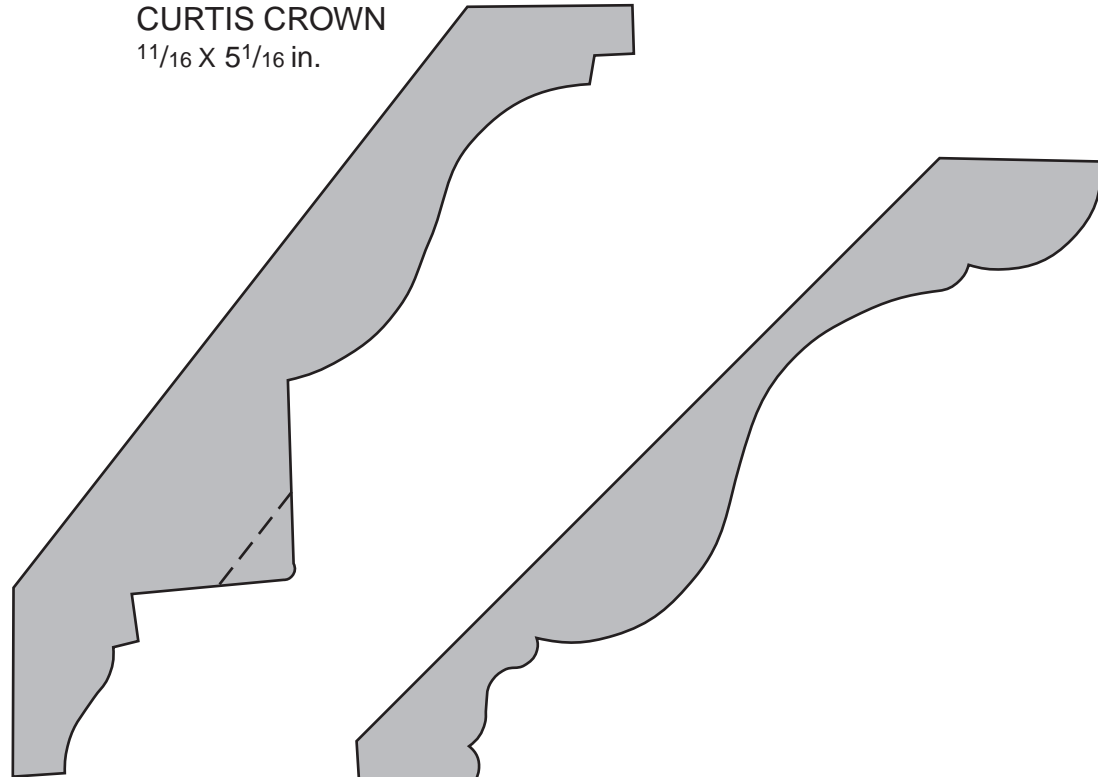

SMITH DENTIL CRN
1 3/16 X 5 5/16 in.

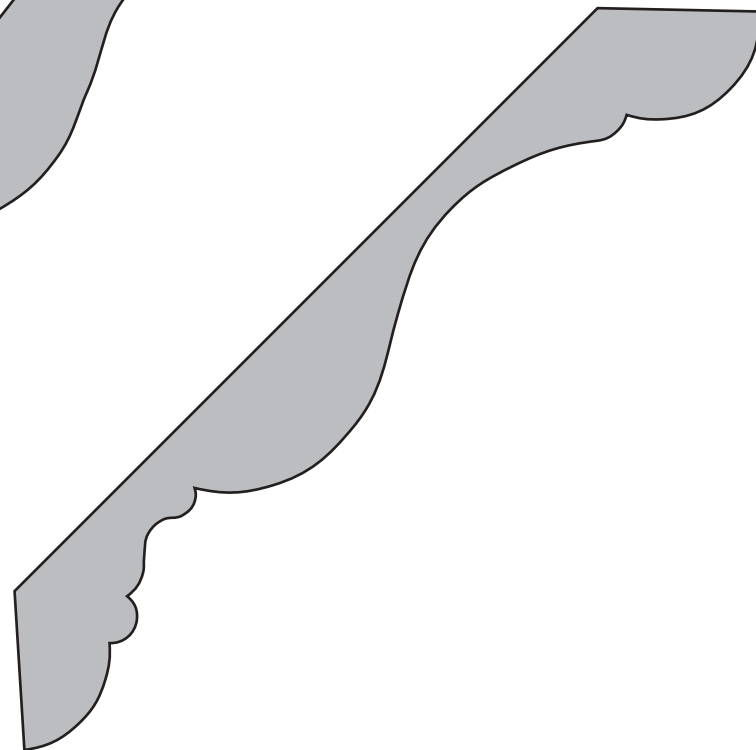

SM1157
3/4 X 5 3/8 in.

CROWN



Many more profiles available, call... 1-800-861-0734 • FAX 1-800-861-0737

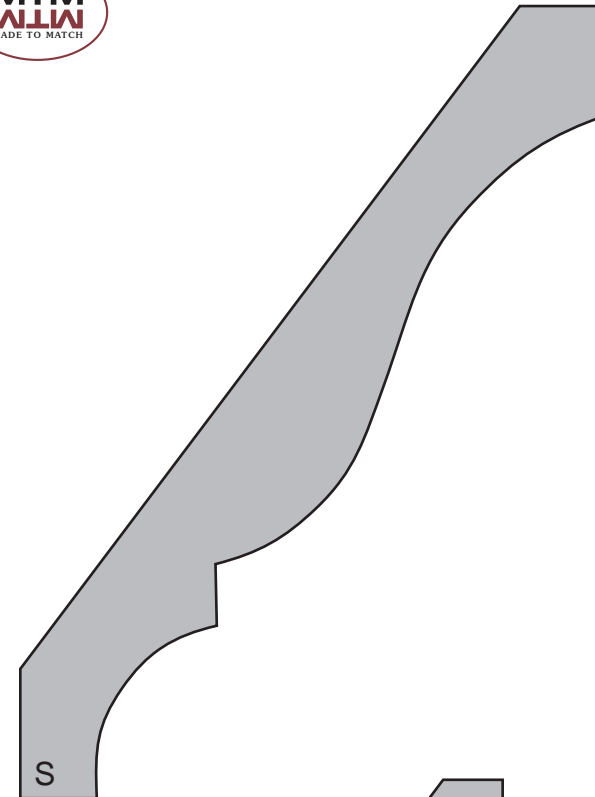

CM45 (1-1/8" Cove)
1 1/16 X 5 1/4 in.

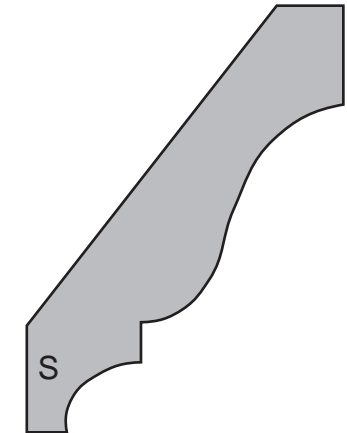

CM52
9/16 X 2 3/4 in.

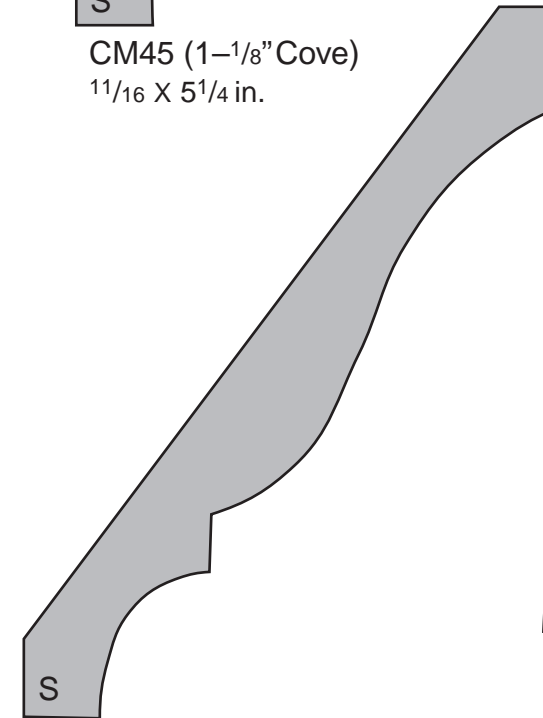

CM47
9/16 X 4 5/8 in.

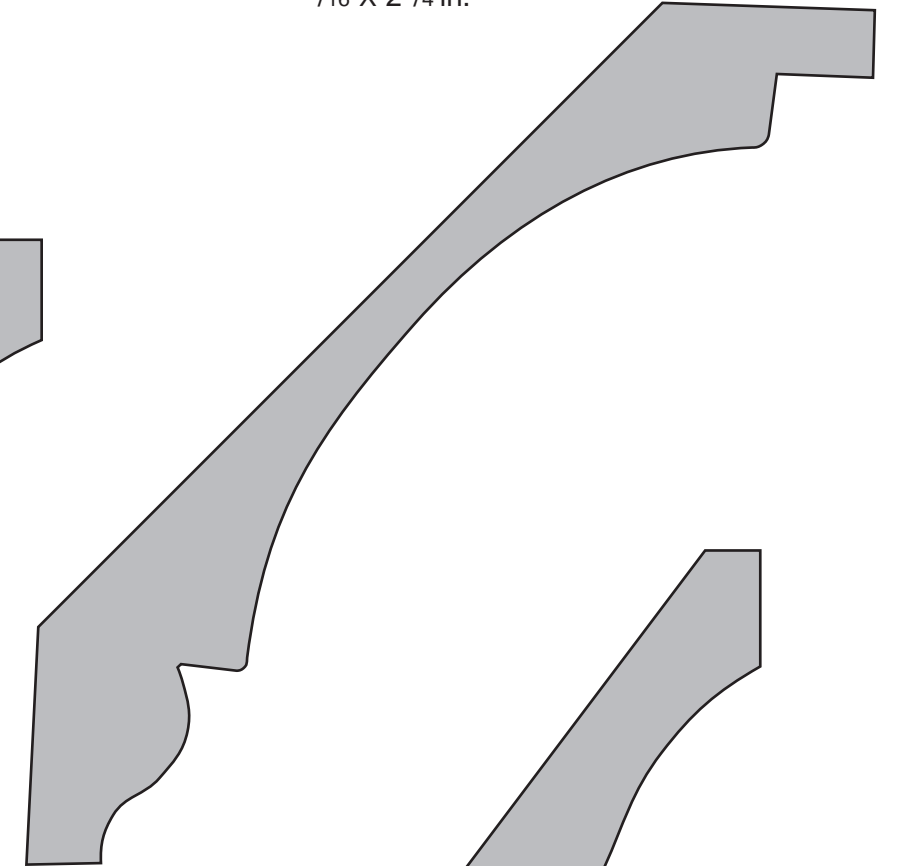

SM1160
1 3/4 X 6 1/4 in.

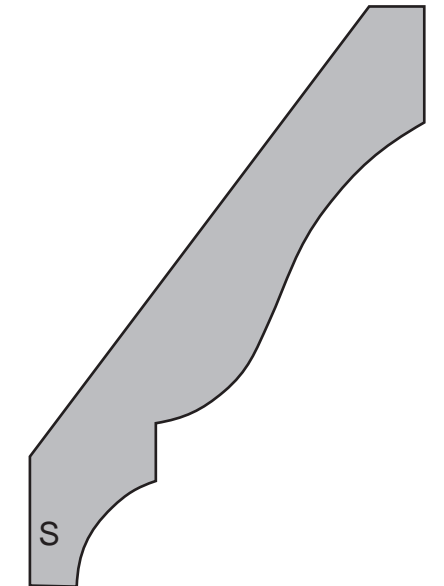

CM49
9/16 X 3 5/8 in.

CROWN



1-800-861-0734 • FAX 1-800-861-0737

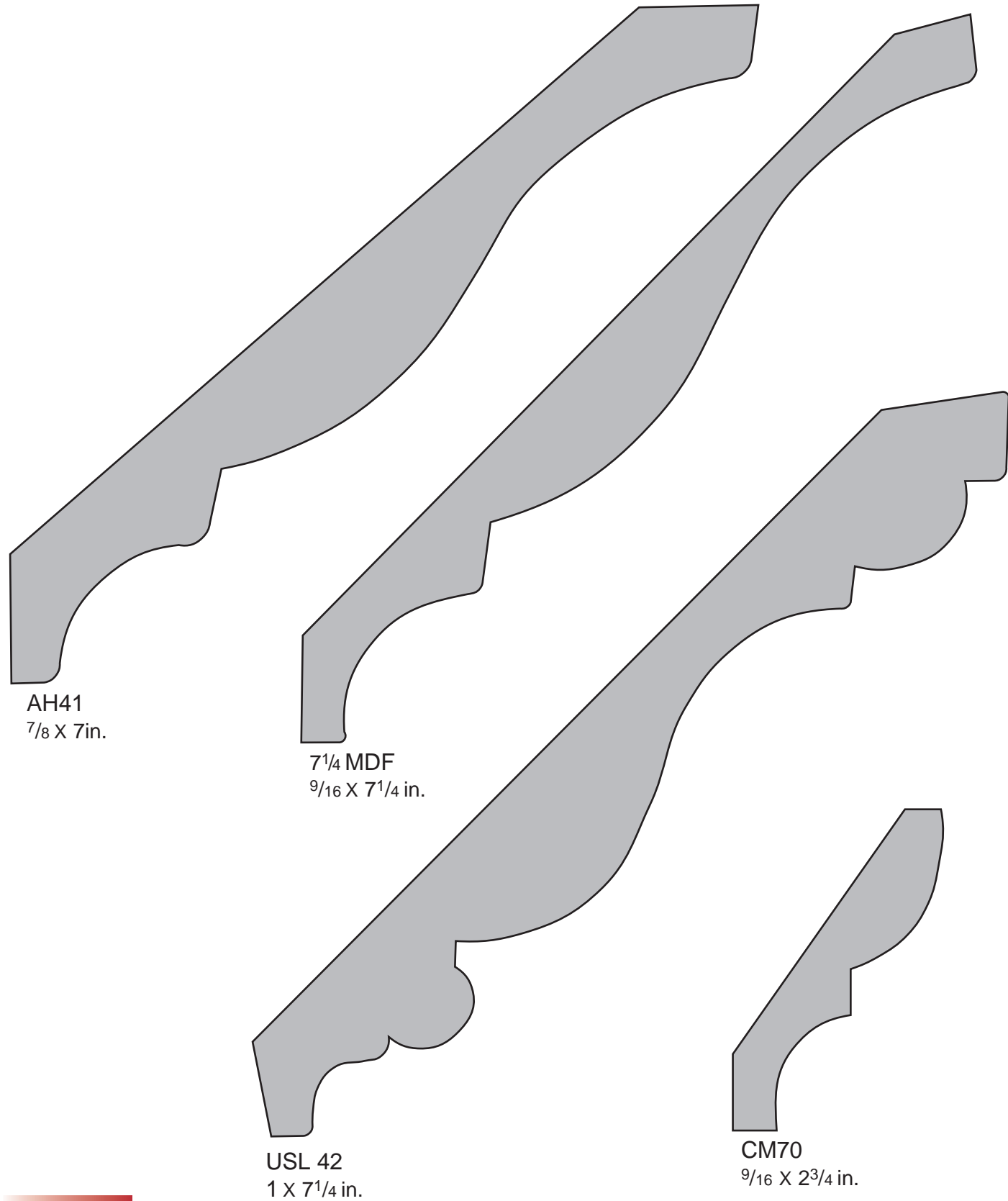

AH41
7/8 X 7 in.

7 1/4 MDF
9/16 X 7 1/4 in.

USL 42
1 X 7 1/4 in.

CM70
9/16 X 2 3/4 in.

CROWN



Many more profiles available, call... 1-800-861-0734 • FAX 1-800-861-0737

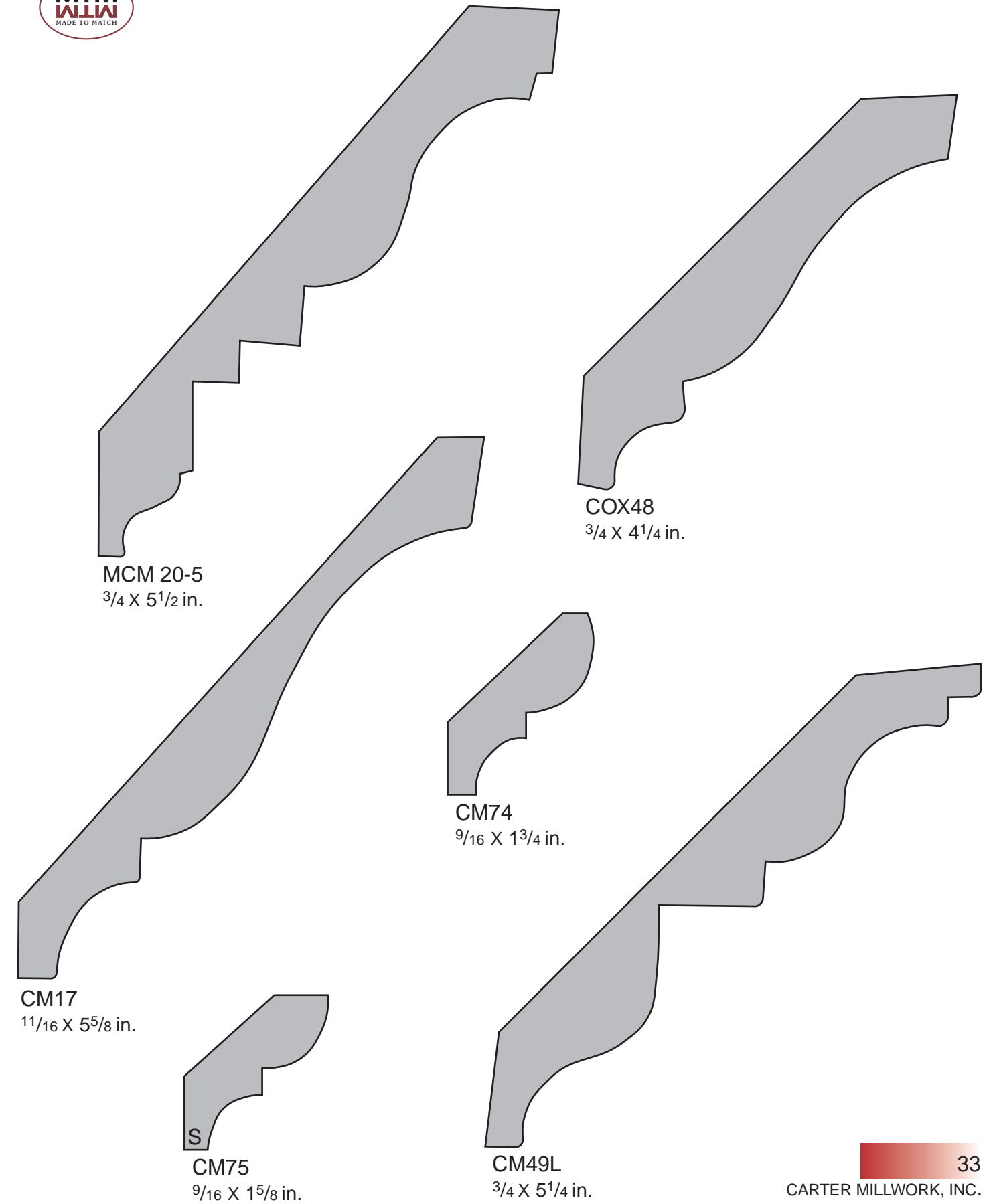

MCM 20-5
3/4 X 5 1/2 in.

COX48
3/4 X 4 1/4 in.

CM74
9/16 X 1 3/4 in.

CM17
1 1/16 X 5 5/8 in.

S
CM75
9/16 X 1 5/8 in.

CM49L
3/4 X 5 1/4 in.

CROWN BACKER



1-800-861-0734 • FAX 1-800-861-0737

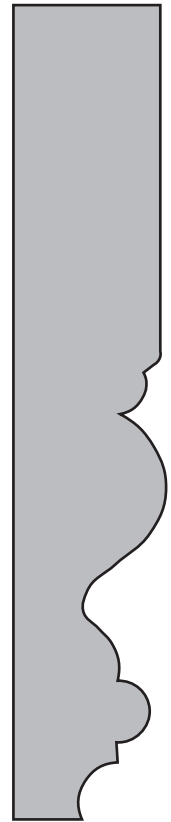

SM4008
3/4 X 4 1/4 in.

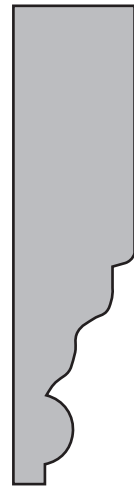

CRB250
5/8 X 2 1/2 in.

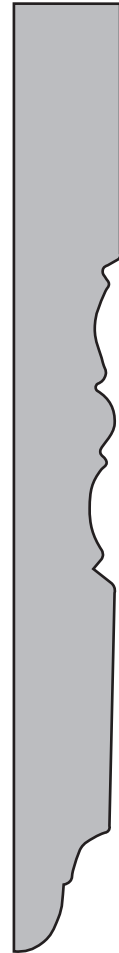

AH19
5/8 X 4 15/16 in.



WINDSOR
5/8 X 3 1/4 in.



CM2
1 1/16 X 2 1/2 in.

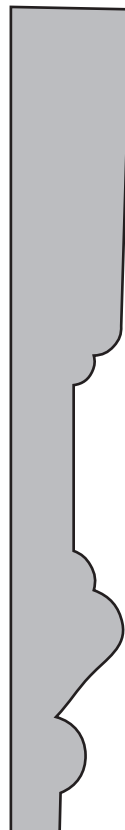

1701
5/8 X 4 5/16 in.

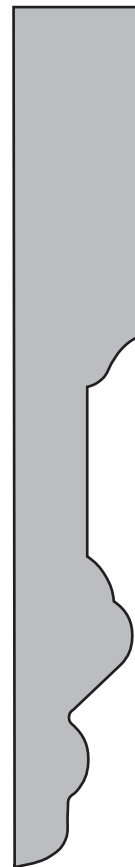

BR CROWN
ENHANCER
5/8 X 4 1/2 in.

BASES



Many more profiles available, call... 1-800-861-0734 • FAX 1-800-861-0737



CM810
5/8 X 7 1/4 in.



CM618
9/16 X 5 1/4 in.



CM710
9/16 X 4 1/4 in.



CM663
9/16 X 3 1/4 in.



BCB500
5/8 X 5 1/4 in.
Also Available:
BCB300
5/8 X 3 1/4 in.
BCB400
5/8 X 4 1/4 in.
BCB700
5/8 X 7 1/4 in.
BCB925
3/4 X 9 1/4 in.

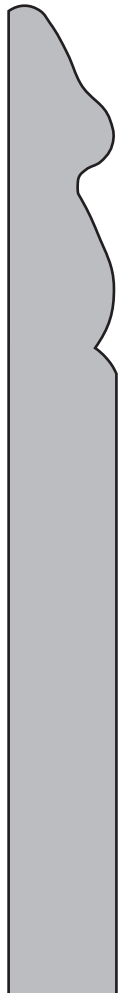

MS5180
9/16 X 5 1/4 in.

BASES



1-800-861-0734 • FAX 1-800-861-0737

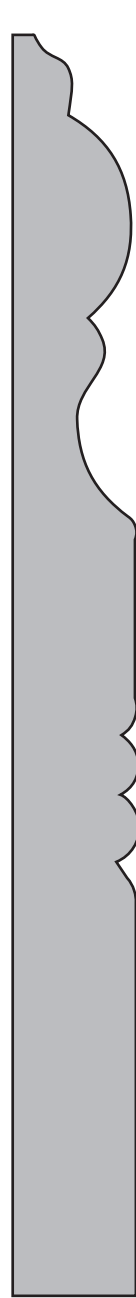

612
9/16 X 6 9/16 in.



SM97
3/4 X 5 1/2 in.



S
CM610
9/16 X 5 1/4 in.



S
CM623
9/16 X 3 1/4 in.



CM753
9/16 X 3 1/4 in.
Also Available:
CM750
9/16 X 4 1/4 in.
CM750W
9/16 X 5 1/4 in.



CM218
9/16 X 5 1/4 in.

BASES



Many more profiles available, call... 1-800-861-0734 • FAX 1-800-861-0737



S
CM616
1 1/16 X 6 1/8 in.



TWPB
1 1/16 X 5 1/4 in.



MDF714
5/8 X 7 1/4 in.



BBJ725
3/4 X 7 1/4 in.

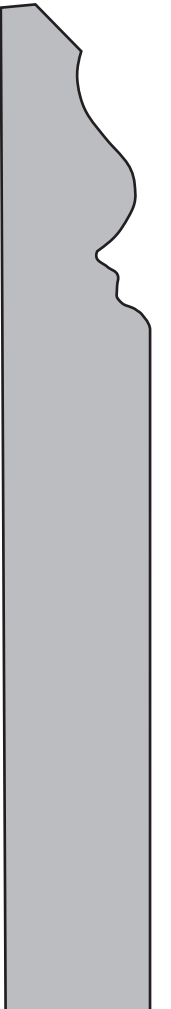

BBJ525
3/4 X 5 1/4 in.
Also Available:
BBJ325
3/4 X 3 1/4 in.
BBJ425
3/4 X 4 1/4 in.

BASES

1-800-861-0734 • FAX 1-800-861-0737

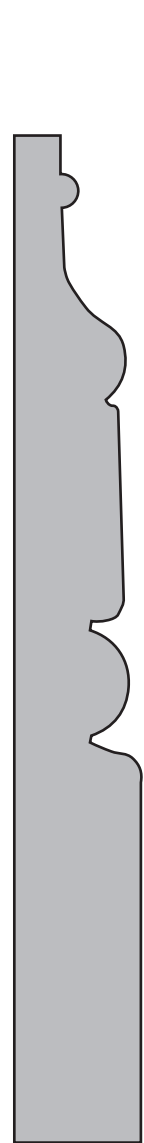

BLB525
5/8 X 5 1/4 in.
Also Available:
BLB425
5/8 X 4 1/4 in.
BLB725
5/8 X 7 1/4 in.

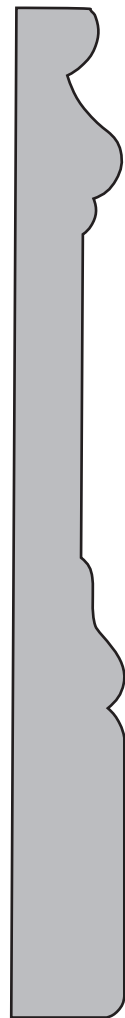

VICTORIAN BASE
9/16 X 5 1/4 in.

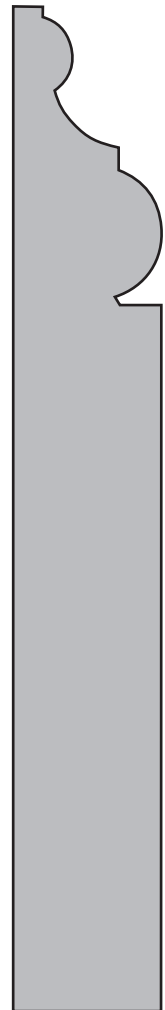

MBC38-5
3/4 X 5 1/4 in.



LDFBA718
5/8 X 7 1/8 in.



AH617
1 1/8 X 7 in.

BASE CAPS

Many more profiles available, call... 1-800-861-0734 • FAX 1-800-861-0737

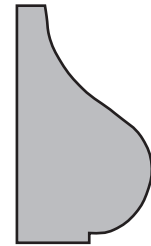

CM166
1 1/16 X 1 1/4 in.



CM164
1 1/16 X 1 1/8 in.



CM163
1 1/16 X 1 3/8 in.

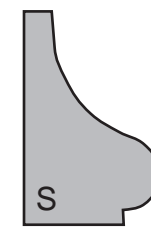

CM167
1 1/16 X 1 1/8 in.



1201
1 1/16 X 1 1/4 in.



SM30
3/4 X 1 3/8 in.

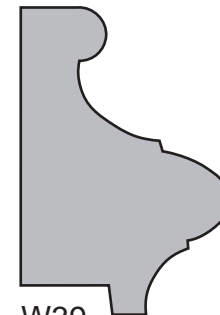

W39
1 1/8 X 1 1/2 in.

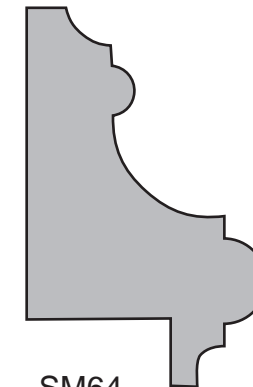

SM64
1 1/4 X 2 in.



MS287
1 7/8 X 2 1/16 in.



SM54
5/8 X 1 3/8 in.

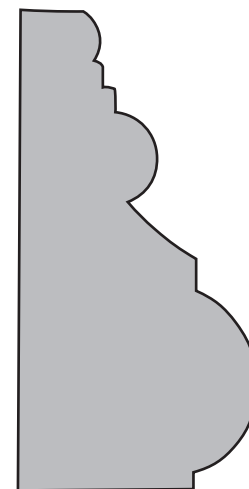

SM43
1 1/4 X 2 1/2 in.

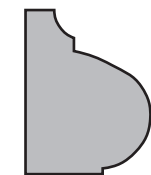

LWP 114
1 1/16 X 7/8 in.

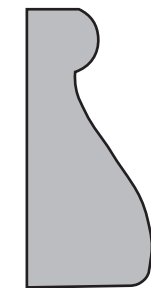

BCB 150
1 1/16 X 1 1/2 in.

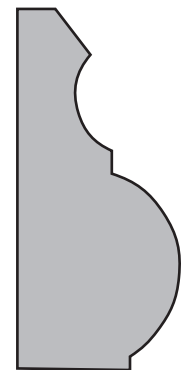

SM40
7/8 X 1 7/8 in.

CHAIR RAIL



1-800-861-0734 • FAX 1-800-861-0737

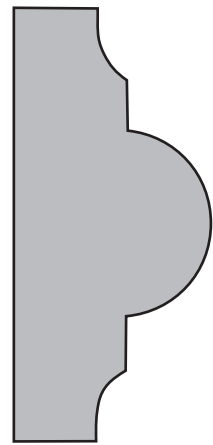

C136
1¹/₁₆ X 2¹/₄ in.

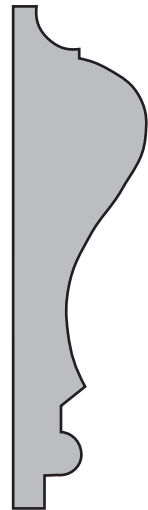

CM390
1¹/₁₆ X 2⁵/₈ in.

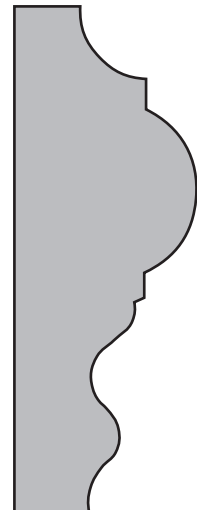

4
1⁵/₁₆ X 2⁵/₈ in.

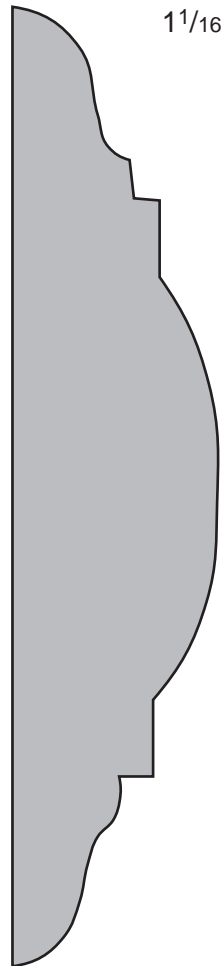

CR560
1 X 5 in.

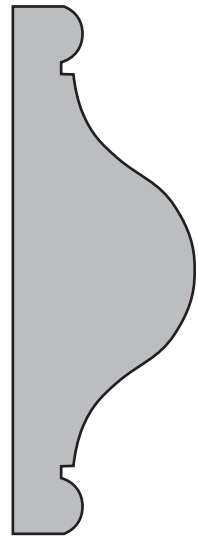

CM302
1¹/₁₆ X 2³/₄ in.

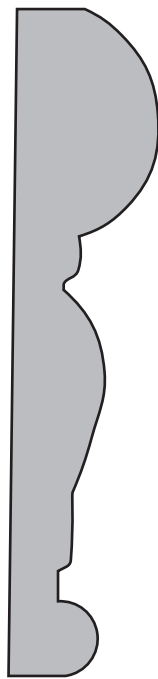

CR290
3/4 X 3¹/₂ in.

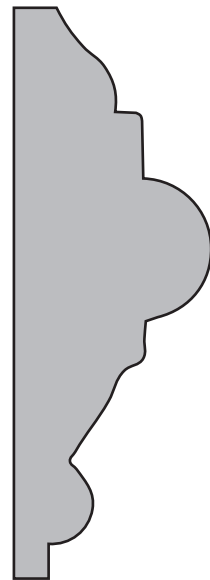

CRAL333
1 X 3 in.

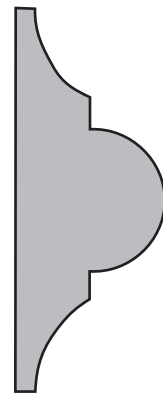

HH133
3/4 X 2 in.

CHAIR RAIL



Many more profiles available, call... 1-800-861-0734 • FAX 1-800-861-0737

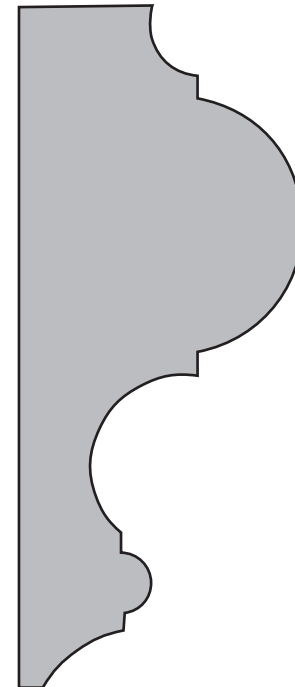

SM225
1³/₈ X 3⁵/₈ in.

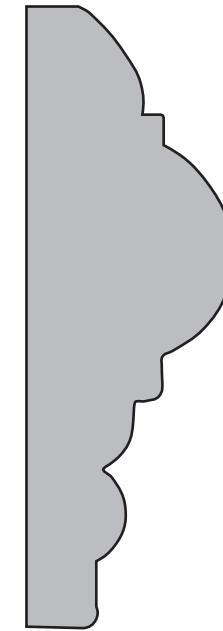

MD4
1¹/₁₆ X 3¹/₄ in.

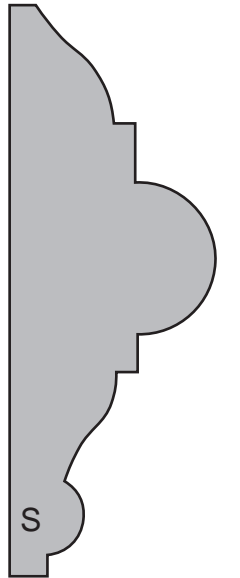

CM300
1¹/₁₆ X 3 in.

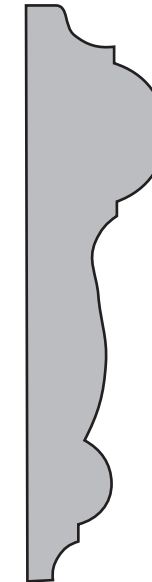

CM297
1¹/₁₆ X 3 in.

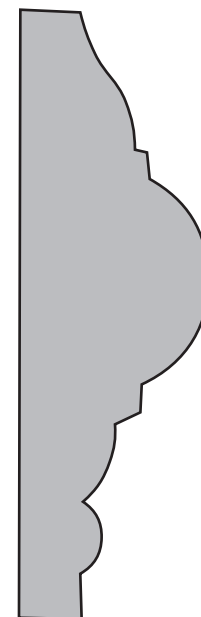

GP200
1 X 3¹/₄ in.



CRA350
3/4 X 3¹/₂ in.

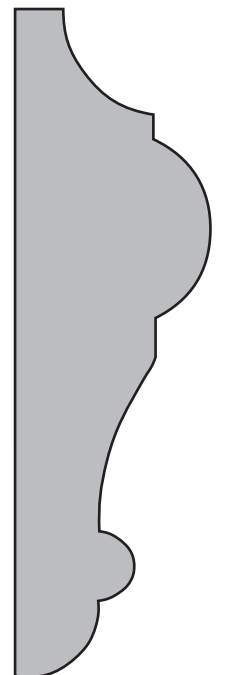

CM397
1 X 3¹/₂ in.

CHAIR RAIL BACKER



1-800-861-0734 • FAX 1-800-861-0737

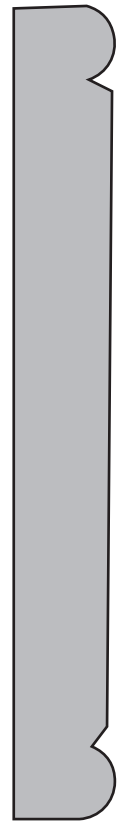

CM957
1/2 X 4 1/4 in.



CM425 (C135)
1/2 X 4 1/2 in.

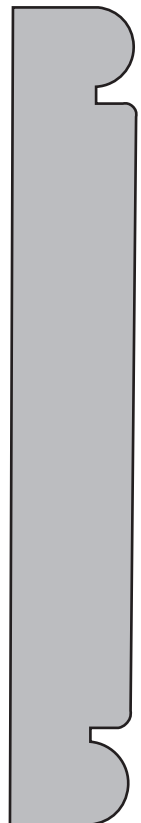

CRB425
3/4 X 4 1/4 in.



CM398
1/2 X 5 1/4 in.

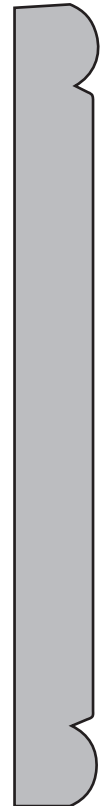

CM956
7/16 X 4 1/4 in.

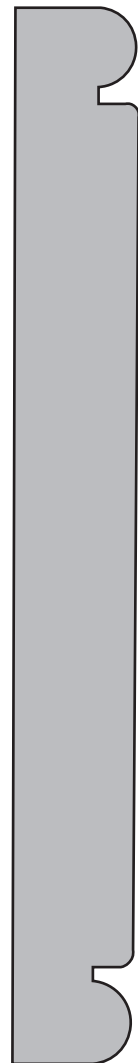

CRB525
3/4 X 5 1/2 in.

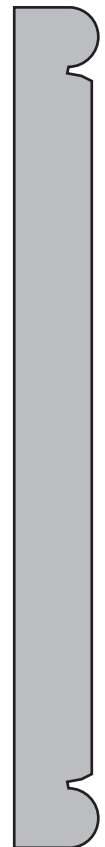

CM6
7/16 X 4 1/2 in.

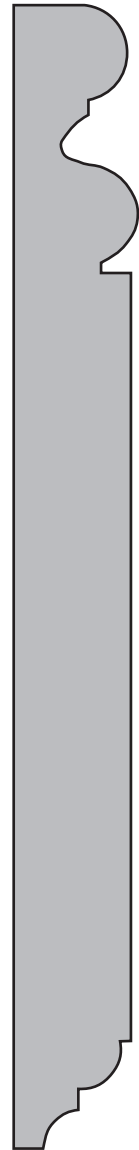

426
5/8 X 6 in.

PANEL MOULDING



Many more profiles available, call... 1-800-861-0734 • FAX 1-800-861-0737

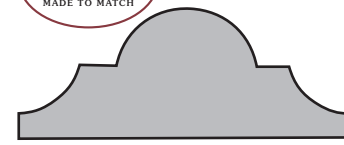

MPM20
3/4 X 1 1/2 in.



PM118
3/4 X 1 in.

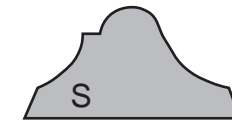

CM183
9/16 X 1 1/8 in.



A9
9/16 X 1 1/4 in.

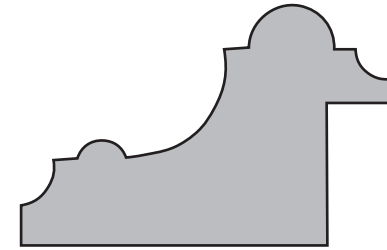

SM64
1 1/4 X 2 in.



PM43
15/16 X 2 1/8 in.

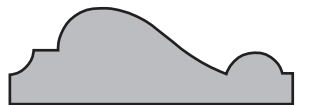

CM184
1/2 X 1 1/2 in.

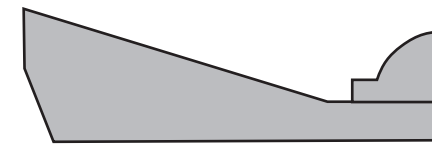

57
1 1/16 X 2 1/4 in. 70
3/8 X 1/2 in.

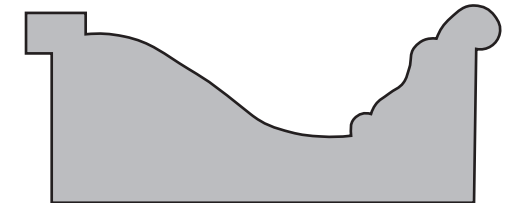

SM3514
15/16 X 2 3/8 in.

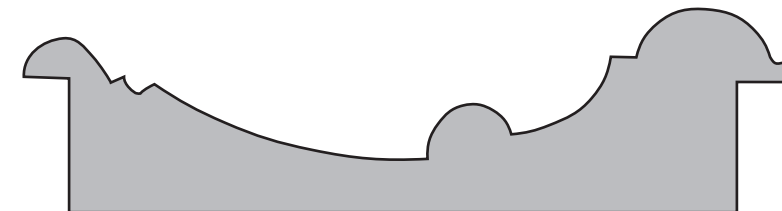

PM5126
1 1/16 X 4 1/16 in.

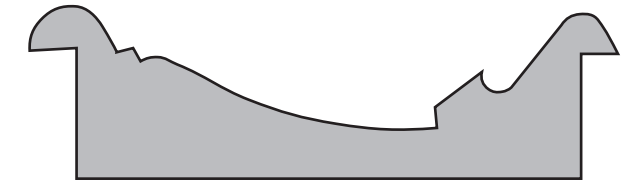

PM5127
7/8 X 3 1/16 in.

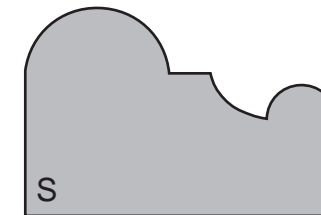

C42
1 1/16 X 1 5/8 in.
RABBETED
Also Available:
C42R 1/2
C42R 3/4

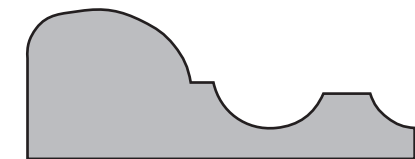

PM250
3/4 X 2 in.
RABBETED
Also Available:
PM250R4
1/2 in.RAB
PM250R5
3/4 in.RAB

BRICK MOULDING



1-800-861-0734 • FAX 1-800-861-0737



EC181
1 1/4 X 3 1/4 in.



CM175
1 1/16 X 2 in.

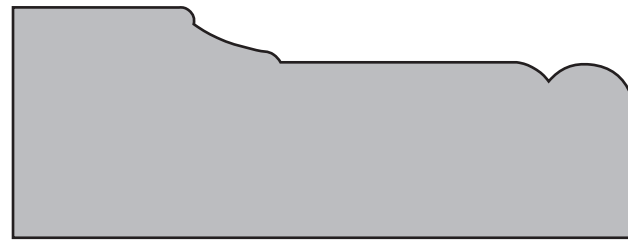

WM179
1 1/4 X 3 1/4 in.

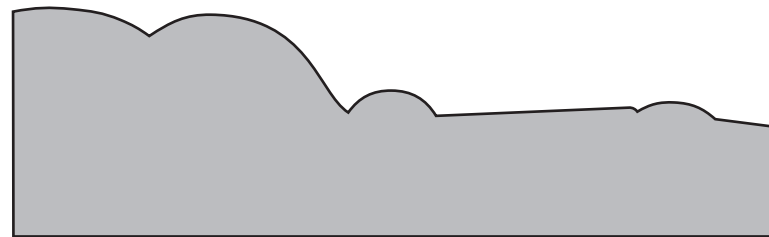

CONGRESSIONAL BMC (EC185)
1 1/4 X 4 in.

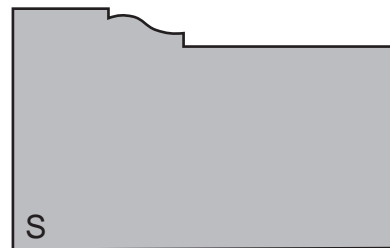

CM180
1 1/4 X 2 in.

RAKES



Many more profiles available, call... 1-800-861-0734 • FAX 1-800-861-0737

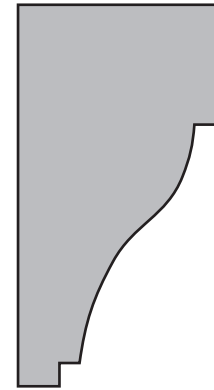

CM287
1 1/16 X 2 in.

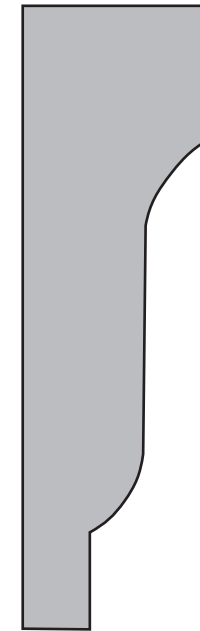

CM1206
1 X 3 1/16 in.



CM212
5/8 X 2 1/2 in.

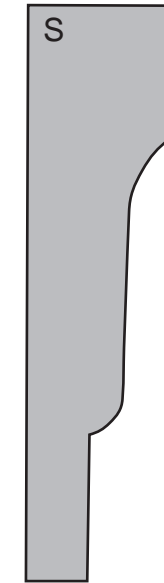

CM28
3/4 X 3 in.

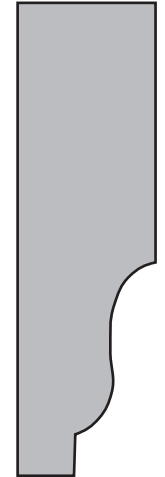

CM207
1 1/16 X 2 1/2 in.

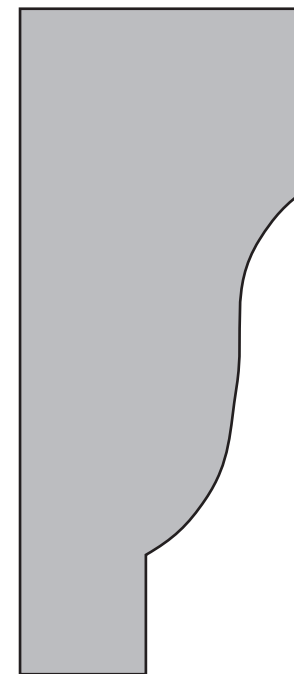

CM29
1 1/2 X 3 1/2 in.

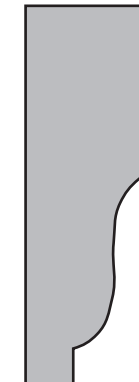

CM209
1 1/16 X 2 in.



CM210
5/8 X 1 5/8 in.

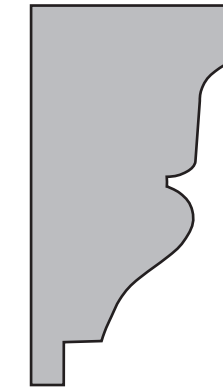

SM41 (WM286)
1 1/16 X 2 in.

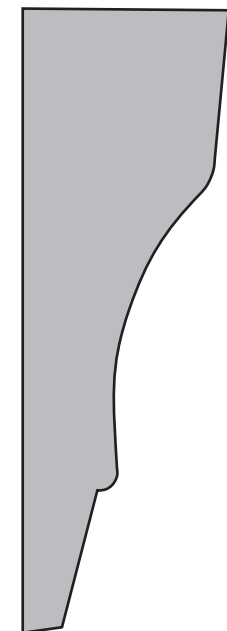

WP207
1 1/8 X 3 1/4 in.



LWP286
1 1/16 X 2 in.

VARIATIONS



1-800-861-0734 • FAX 1-800-861-0737

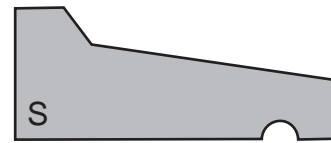

CM197
11/16 X 15/8 in.

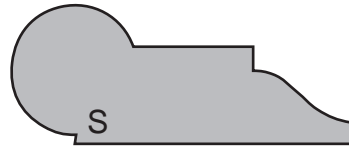

CM273
11/16 X 13/4 in.



CM988
3/8 X 1 1/2 in.
Also Available:
CM987
3/8 X 2 in.



CM137
9/16 X 1 1/4 in.



HR150
1 1/2 X 3/4 in.



HR100
1 X 1/2 in.

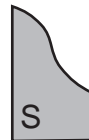

CM131
(Ogee Shoe)
7/16 X 3/4 in.

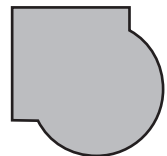

PENCIL MOULD
5/8 X 5/8 in.

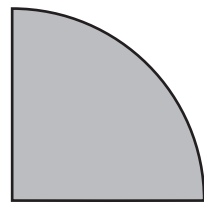

1in. QR.
1in. X 1in.

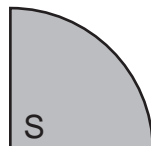

CM105
3/4 X 3/4 in.

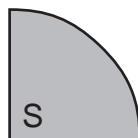

CM106
11/16 X 11/16 in.



CM936
3/8 X 1 3/8 in.
Also Available:
CM937
3/8 X 1 1/4 in.

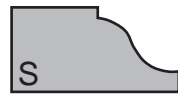

CM940
7/16 X 7/8 in.
Also Available:
CM941A
7/16 X 5/8 in.
CM941
7/16 X 3/4 in.

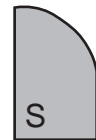

CM127
7/16 X 11/16 in.



CM126
1/2 X 3/4 in.

VARIATIONS



Many more profiles available, call... 1-800-861-0734 • FAX 1-800-861-0737

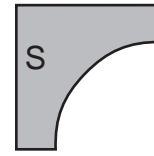

CM93
3/4 X 3/4 in.

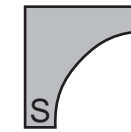

CM100
11/16 X 11/16 in.



CM101
1/2 X 1/2 in.



SCOTIA
WM1075
1/2 X 3/4 in.

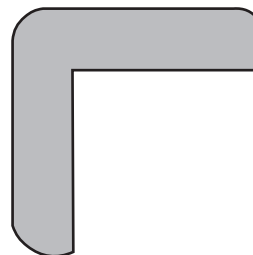

CM204
1 5/16 X 1 5/16 in.

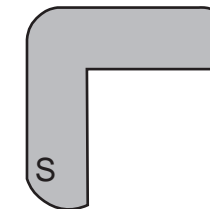

CM205
1 1/16 X 1 1/16 in.

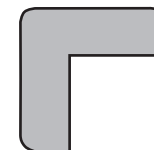

CM206
3/4 X 3/4 in.

| FLEX JAMB | |
|------------|------------------|
| 496 | 3/4 X 4 9/16 in. |
| 696 | 3/4 X 6 9/16 in. |
| EASED EDGE | |

S4S

| | |
|-----------|------------------|
| 1 X 2 | 3/4 X 1 1/2 in. |
| 1 X 2 NET | 3/4 X 2 in. |
| CMXJ | 3/4 X 3 1/16 in. |
| 1 x 4 | 3/4 X 3 1/2 in. |
| 1 x 6 | 3/4 X 5 1/2 in. |
| 1 x 8 | 3/4 X 7 1/2 in. |
| 1 x 10 | 3/4 X 9 1/4 in. |
| 1 x 12 | 3/4 X 11 1/4 in. |
| 5/4 x 4 | 1 X 3 1/2 in. |
| 5/4 x 6 | 1 X 5 1/2 in. |
| 5/4 x 8 | 1 X 7 1/2 in. |
| 5/4 x 10 | 1 X 9 1/4 in. |
| 5/4 x 12 | 1 X 11 1/4 in. |

Many more profiles available, call... 1-800-861-0734 • FAX 1-800-861-0737

PAGE 5- CASINGS

CM356
CM366
CM445
CM444
CM376
CM444A
CM470
CM442
CM1
CM97
PAGE 6
CCC525
C606R
SM75
SM85
C606F
SM5806
PAGE 7
C600R
CM14R
CM14F
PT338F
PT338R
1002
1002M
CNF312
CCC350
SM8
PAGE 8
SM12
CM445A
CFC 214
CFC 315 (NS)
CFC 425 (NS)
24112 PCA
2814
CM460
CM371
MD2
NH234
PAGE 9
SM7
CM327
CRK350
PM719
WM351
CBG275
RIDOUT376
CAS50
CKN425

PAGE 10

LSM2060
BM1188
CN400
CBG400
CRC350
CRC425
PAGE 11
CGA425
COXCOMB
NH358
WM371
CKN350
CM361
SM83
PAGE 12
SM80
CJF425
LWM 97
C425
MISS JENNY
CAG425
PAGE 13
CM433
CM473
CAS30
CM452
SM2050
BM995
SM 5701
PAGE 14
CAM350
BM1455
C352
RBI SPR3
BM255
CAM400
SM84
PAGE 15
RBI208
CTE350
CM683
TM1
399
MS1661
SM2051
CW1
PAGE 16
C351
WM444
LDFCA4
CKM234
SM82
EC490

PAGE 17

CBG300
SM47
PT312
SM2
CM466
PRESIDENTIAL
PAGE 18
P LARGE HOWE
TMMH
DELTA HOWE
CKN535
CM10
CVA350
CVA525
MSI1
PAGE 19-BACK BANDS
C282
CM809
4048USBB
97BB
SM68
CM142
4048
C281
3436BB
SM2513
PAGE 20
SM2501-2
SM2501
CM280
BB200
SM2510
SM2511-2
SM2511
CM289
CRC150
GP281
CM281
PAGE 21- CROWN
SM27
SM603
BM6
SM29
SM42
PAGE 22
AH40
CM48
WM80
CM541
COLONIAL COVE
PAGE 23
SM81
SM86 (NS)
RBCCM625
TP41
CM449C
CM6449C (NS)

PAGE 24

SM1136
BBS725
CCM725
CCM525 (NS)
CCM425 (NS)
BBS111
PAGE 25
SM 21
EC36
SM38
CM725L
CM525L
PAGE 26
SM32
CM375L
RB4
BM51245
RB7
PAGE 27
AH61
CRN39
CM70(COX)
CM53
PAGE 28
MTV629
COVE
TLC500
RBCCM525
PAGE 29
CBM1554
24168-US-CR
9 DENTIL
SM712
PAGE 30
CM549
CM37
SMITH DENTIL CRN
SM1157
PAGE 31
CM45 (1-1/8" Cove)
CM52
CM47
SM1160
CM49
PAGE 32
AH41
MS43
USL42
CM70
PAGE 33
MCM 20-5
COX48
CM17
CM74
CM75
CM49L



PAGE 34-CROWN BACKERS

SM4008
CRB250
AH19
CM2
WINDSOR
1701
BR CROWN ENHANCER
PAGE 35-BASES
CM810
CM618
CM710
BCB500
BCB300 (NS)
BCB400 (NS)
BCB700 (NS)
BCB925 (NS)
MS5180
CM663
PAGE 36
612
SM97
CM610
CM623
CM218
CM753
CM750 (NS)
CM750W (NS)
PAGE 37
CM616
TWPB
MDF714
BBJ725
BBJ525
BBJ325 (NS)
BBJ425 (NS)
PAGE 38
BLB525
BLB425 (NS)
BLB725 (NS)
VICTORIAN BASE
MBC38-5
LDFBA718
AH617
PAGE 39 BASE CAPS
CM166
CM164
CM163
CM167
1201
SM30
W39
SM64
MS287
SM54
SM43
LWP 114
BCB 150
SM40

PAGE 40 CHAIR RAIL

C136
CM390
4
CR560
CM302
CR290
CRAL333
HH133
PAGE 41
SM225
MD4
CM300
GP200
CM297
CRA350
CM397
PAGE 42 CHAIR RAIL BACKER
CM957
CRB425
CM956
CM6
CM425(C135)
CM398
CRB525
426
PAGE 43 PANEL MOULDING
MPM20
PM118
CM183
A9
SM64
PM43
CM184
57,70
SM3514
PM5127
PM5126
C42
C42R1/2(NS)
C42R3/4 (NS)
PM250
PM250R4(NS)
PM250R5(NS)
PAGE 44 BRICK MOULDING
AH181
CM175
WM179
CONGRESSIONAL BMC
CM180
PAGE 45 RAKES
CM287
CM1206
CM212
CM28
CM207
CM29
CM209
CM210

PAGE 45 CONTINUED

SM41(WM286)
LWP286
WP207
PAGE 46 VARIATIONS
CM273
CM197
CM137
CM988
CM987 (NS)
HR150
HR100
CM131
PENCIL MOULD
1IN. QR.
CM105
CM106
CM936
CM937 (NS)
CM940
CM941A (NS)
CM941 (NS)
CM127
CM126
PAGE 47
CM93
CM100
WM1075
CM101
CM204
CM205
CM206
S4S- 13 Sizes
FLEX JAM 496 &696

We have many more profiles available that may suit your specific design requirements. We are always available to recreate your custom patterns at...
1-800-861-0734



4264 Old Linwood Road
Linwood, NC 27299
1-800-861-0734
FAX 1-800-861-0737

US MAIL AT:

PO BOX 189
Linwood, NC 27299



(NS)=Not shown but available

